



# AGRIPARTS & REPAIRS

## COMPONENTS CATALOGUE

6<sup>TH</sup>  
EDITION

AGRICULTURAL SUPPLIES



- TILLAGE
- HAY
- HARVEST
- LIQUID TRANSFER
- WORKSHOP EQUIPMENT

WELCOME TO AGRIPARTS & REPAIRS COMPONENTS CATALOGUE.



AUSTRALIAN DISTRIBUTOR FOR



MAIN PARTNERS



FOR ALL ENQUIRIES PLEASE CONTACT P: 08 9362 6811 F: 08 9361 3263  
29 WELSHPOOL RD, WELSHPOOL WA 6106, WESTERN AUSTRALIA PO BOX 232 CLOVERDALE WA 6985  
Email: sales@agriparts.com.au

PRODUCTS AND PRICES ARE SUBJECT TO CHANGE WITHOUT NOTICE

# CONTENTS

## TILLAGE EQUIPMENT

iTill® - INTELLIGENT TILLAGE	2
STILETTO SEEDING SYSTEMS	5
MAXIPOINT	
Slot Mate Points	14
Bolt On Points	16
Ezy Fit System, Single Bolt On Points	17
Seed Boot Cultivators	18
Inline Series Boots	20
Bourgault Paralink	21
Morris Quantum Seeding Kit	22
Ausplow Solutions	23
Conserva Pak / JD 1870 Solutions	24
MAXIPOINT / KHART COULTERS	25
MAXIPOINT SINGLE PRESS WHEEL SYSTEM	27
PRESSWHEELS	28
SEED BRAKES	29
BLOCKAGE PREVENTION SYSTEMS	30
AIRSEEDER HEADS / RISER (RAYCOL)	31
TYRESHIELD	32
SUPA VEYAS CONVEYOR	33
AIRSEEDER REPLACEMENT CONVEYOR BELTS	34
AIRSEEDER HEAVY DUTY FLEXIBLE COUPLING	34
AIRSEEDER HOSE	35
SPARE PARTS	
Bourgault	36
Chamberlain	36
Ezee-On	37
Forward Engineers	37
Grizzly	38
Jet Stream 5:1	39
John Deere/ Conserva Pak	40
Morris	41
Simplicity	41

## LIQUID TRANSFER EQUIPMENT

PRECISION WETTER	42
LQS20, LQS70	43
LQS120, LQS180	44
SINGLE AND DUAL STACKER KITS	45
SECTION CONTROL STACKER KITS	46
AIRTOOL MANIFOLD CONFIGURATIONS	47
LIQUID SYSTEMS SPARES	48
HYPRO FLOW CONTROL	56
LIQUID SYSTEMS RATE TABLE	56
CHEMICAL TRANSFER SOLUTIONS	57
SHURflo 12, 24 and 240VOLT PUMPS	58
CENTRIFUGAL PUMPS HYPRO	59

## FIRE AND PROTECTION EQUIPMENT

DAVEY PUMPING EQUIPMENT	63
COMPACT FIRE FIGHTING UNITS	65
DAVEY REMOTE START FIREFIGHTER	68
PUMPING SPARES	69
ACCUFIRE FIRE UNITS	71
DAVEY HOUSEHOLD PUMPS	72
DAVEY WATER DISINFECTION	73

## HAY EQUIPMENT

DELMHORST MOISTURE METERS	75
DELMHORST MOISTURE METERS SPARES	76
BALER TWINE	78
GRAIN STORAGE - GRAINFLEX	81
SERVICE EXCHANGE GEARBOXES	82
HAY FORKS	82
SPARE PARTS	
Sitrex	83
Teagle	83
Vicon	83
Wilkinson	83

## HARVEST EQUIPMENT

DRAPER FRONT BELTING	84
DRAPER FRONT ROLLERS	87
PICKUP BELTS	89
SPARE PARTS	
De Engineers	90
Moylan	90

## HYDRAULIC EQUIPMENT

TIPPER TRAILER KITS	91
HYDRAULIC MOTORS	92
HYDRAULIC COUPLER / MOTORS	93
COUPLINGS	93
HYDRAULIC CYLINDERS	94
SPIRALGUARD	95

## POWER TRANSMISSION EQUIPMENT

CLUTCHES	96
PTO SHAFTS	97
GEARBOXES	98
SIMOL JACKS	99

## WORKSHOP EQUIPMENT

PRESSURE CLEANERS	101
GENERATORS	
Yamaha Silent Inverter Generator	102
Honda Silent Inverter Generator	102
YAMAHA ACCESSORIES	102
GENERATORS	
Dunlite Honda Generators	103
Dunlite Diesel Generators	103
Dunlite Honda Multi-Power Packs Petrol Powered	103
Mine Spec Diesel Generators	103
Mine Spec Options & Accessories	103
AIR COMPRESSORS	104
WELDERS	106

## ELECTRICAL EQUIPMENT

WINCHES	109
SNATCH STRAPS	110
CAMERA KITS	111

<b>SERVICE</b>	<b>112</b>
----------------	------------

PRODUCTS AND PRICES ARE SUBJECT TO CHANGE WITHOUT NOTICE

**T: (08) 9362 6811**

**1**

**F: (08) 9361 3263**

# iTILL® - INTELLIGENT TILLAGE

Introducing iTILL PRO - WiFi enabled implement steering - New for 2017.

## The New iTILL PRO:

iTILL Pro now has wireless finger tip control right from the palm of your hand. Use any smart device, be it tablet or phone to control your implement guidance right from the tractor seat or in a vehicle driving along side the seeder on the go!

iTILL Pro now offers the next level in implement guidance totally independent to the tractors auto steer system accurately guiding the seeder either right down the previous years row or anywhere in between depending on moisture and stubble handling requirements.

If you want to be able to steer your seeder bar either on the row to utilise residual moisture or down the inter row to avoid stubble blockages - iTILL is the only choice.

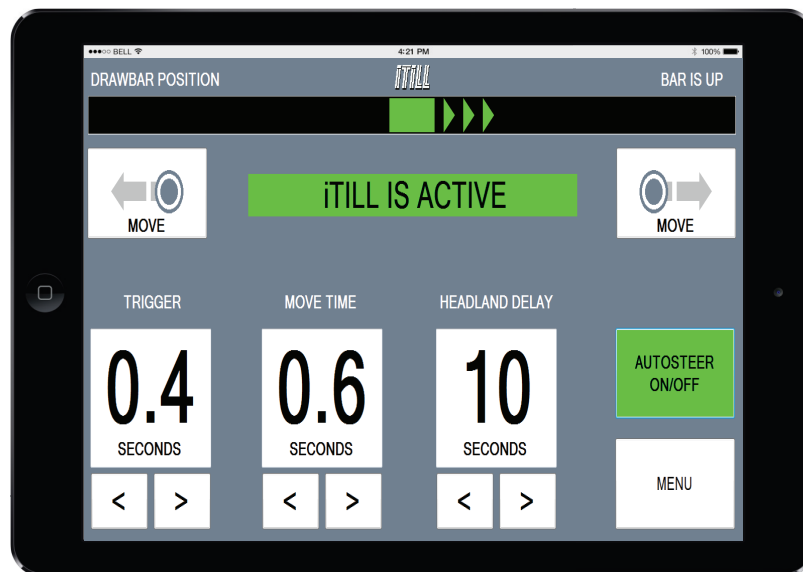

## SMARTS:

### Works the way you do...

iTILL Pro is the only system that integrates seamlessly into the existing hydraulic system of your tractor taking over control of the required hydraulic functions as if you were controlling them with your own hand. iTILL senses when you have begun a new pass and wont activate the system until the tractor and seeder are straight. When iTILL is active you can set the limits as to how far you want the drawbar to steer left or right. If the drawbar is approaching its limits the system will alert you. At the end of the run, the system will centre the drawbar ready for the next run. Multiple row sensors can be run simultaneously where stubble rows have been flattered due to wheel marks from spraying or harvest operations giving 20 mm repeatability year after year.



PRICES EXCLUDE GST

T: (08) 9362 6811

2

F: (08) 9361 3263

# iTILL® - INTELLIGENT TILLAGE

## Keeps your row straight

iTILL allows you to fully customise the sensitivity of the steering. The proprietary software monitors the sensor input and depending on the frequency only adjusting the steering position when required to. This significantly reduces the wear and tare on the hydraulic and steering components on your tractor and seeder.

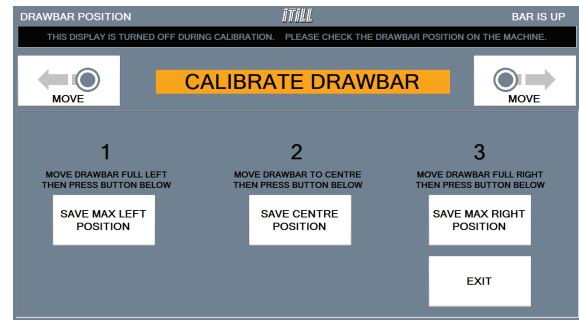

## Awards:

Since its inception in 2012, iTILL has set the standard in the industry receiving a number of awards including best new release, best commercial innovation and best farmer innovation at the 2012 Newdegate Machinery Field Day.

## Research:

A 5 year GRDC initiative in collaboration with CSIRO looking at water infiltration and crop performance when sown on - row verse sowing on the inter - row has used iTILL to provide implement guidance throughout the project.

Left - sown on the inter row  
Right-sown on the row using iTILL Pro

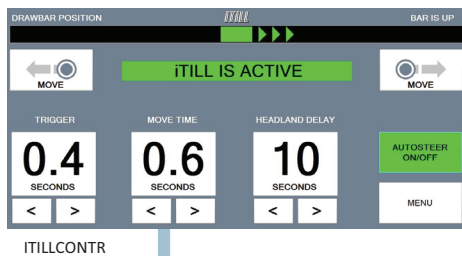

ITILLCPU



ITILLHARTR



ITILLHAR20



ITILLHAR10



PRICES EXCLUDE GST

# iTILL® - INTELLIGENT TILLAGE

## DRAWBAR KITS AVAILABLE FOR STEERING IN ROW OR BETWEEN

### DRAWBAR KIT INCLUDE;

- In Cab Control Module, Camera & wiring looms
- New Hitch to integrate into existing
- Hydraulic rams & hose kit
- All plates and u-bolts to attach to steerable

ORDER NO	DESCRIPTION
OPTIONS	
ITILLHAR10	WIRING HARNESS EXTENSION 10M
ITILLHAR15	WIRING HARNESS EXTENSION 15M
ITILLHAR20	WIRING HARNESS EXTENSION 20M
	HYDRAULIC DIVERTOR VALVE KIT



ORDER NO	MODEL	TYRE SPACING (INCHES)	SUITS
<b>DBS AUSEEDER</b>			
ITILLDBSD260	D260	10	D260-24, D260-32, D260-36, D260-42, D260-48E, D260-54, D260-59
ITILLDBSD300	D300	12	D300-32, D300-36, D300-40, D300-44, D300-46, D300-51, D300-55
ITILLDBSD381	D381	15	D381-28, D381-32, D381-36, D381-40, D381-44, D381-48
<b>BOURGAULT</b>			
ITILLBOU5710	5710	9.8 & 12.6	5710-40, 5710-50
*UPON ORDERING PLEASE SPECIFY TRACTOR BRAND*			

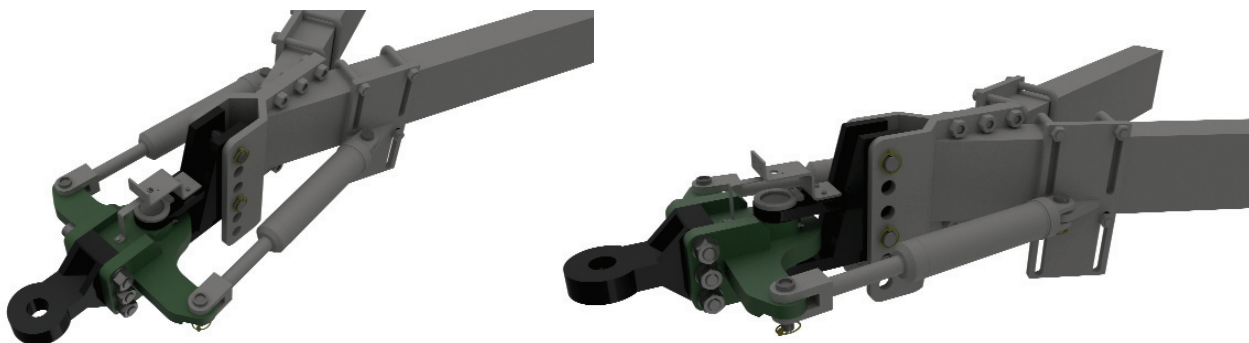

PRICES EXCLUDE GST

# STILETTO SEEDING SYSTEMS

## BENEFITS

Since conception in 2004 with limited release until 2006 when it was made commercially available, Stiletto has earned its exceptional reputation through its unique design.

Providing customers with optimised efficiency and usability, Stiletto is the only closed seeding system designed and suited to Australian conditions.



### Closed Seeding System

Stiletto's closed seeding system provides customers with the highest standard of seed quality than other seeding systems on the market today. Its unique design optimises germination conditions, protecting the seed from risks such as chemical contamination and mouse holing. Join the Stiletto customers who are experiencing higher yields and lower 'in field' costs.

### Speed

Experience both speed and control with Stiletto's unique design which allows you to work through the day without interruption. Its specially designed point offers greater sowing speeds and decreased risk of chemical damage leading to higher yield potential.

### Better Row Competition

Benefit from the reduction of late germination volunteer weeds, like ryegrass. Stiletto's three and four inch split allows seedlings to compete better within the row.

### Chemical Damage

Unlike competitors Stiletto's design promotes even rates of crop growth, whereby the seed is placed under the ground with clean soil on top so the seed is rarely exposed to the elements thus almost eliminating the chance of chemical contamination on all tynes even if Triflurilan is thrown into the row.

### Strength And Durability

Our product is one of the strongest on the market our points are drop forged for superior strength and durability and backed up with a 10mm x 50mm tungsten tile and super durable tungsten grit. The wings and fertiliser adapters are cast using only the best mix of alloys for strength and durability.

PRICES EXCLUDE GST

T: (08) 9362 6811

5

F: (08) 9361 3263

# STILETTO SEEDING SYSTEMS

## HOW IT WORKS

**THE STILETTO SEEDING SYSTEM** is split into three components each having their own affect on achieving the best placement possible. The Point, the Adapter and the Wing. Starting with the 35 degree entry angle and uniquely designed taper in all of our points, it manipulates the flow of soil, creating a more consistent throw pattern and better incorporation of the added chemicals such as Triflurilan and Boxer Gold.

The fertiliser adapter is designed to place the fertiliser approximately an inch below the seed, then as the wing follows through it closes the slot left open by the point and fertiliser adapter.

The wing places the seed, using the bedformers on it's underside, effectively sandwiching the seed and almost eliminating chemical damage caused by affected soil landing in the row.

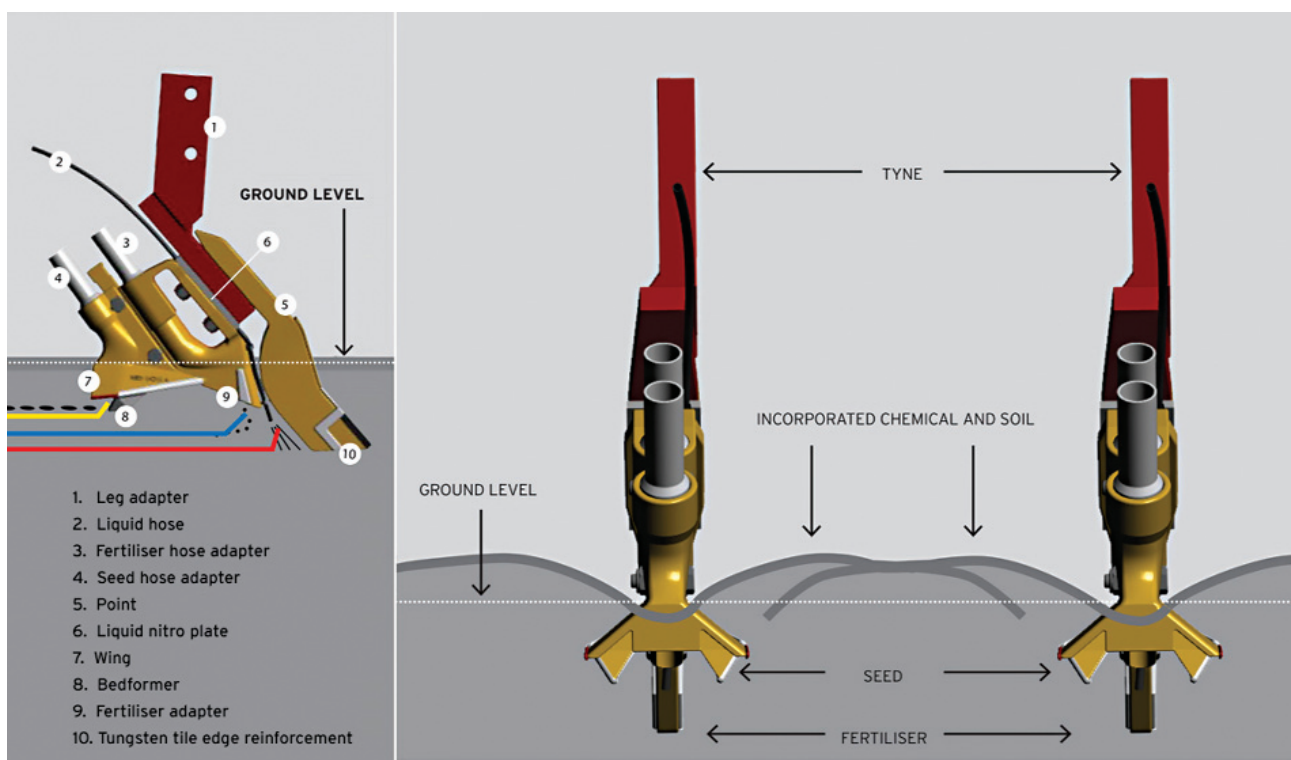

PRICES EXCLUDE GST





T: (08) 9362 6811





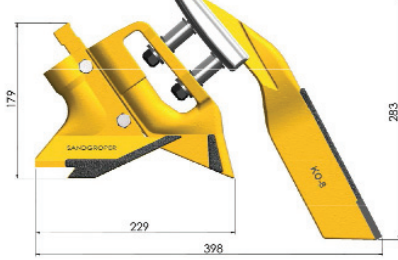









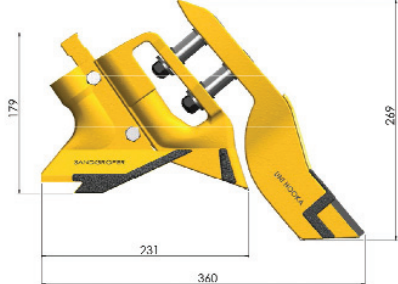

6

F: (08) 9361 3263









# STILETTO SEEDING SYSTEMS

KNOCK ON SYSTEM <b>SYS KO</b>	DIMENSIONS	MAIN FEATURES
	   	<p>The <b>KNOCK ON SYSTEM</b> combines our Knock on Point and mount, stiletto wing and fertiliser adapter. Farmers are able to customise this system by mixing and matching any of the Stiletto wings.</p> <p>Designed for use with curved point mount (Flexi-Coil, Morris and John Deere).</p> <p><b>The KO-8 System contains</b></p> <ul style="list-style-type: none"> <li>1 x Knock on mount</li> <li>1 x Knock on point</li> <li>2 x Bolts for mounting to tyne</li> <li>2 x Bolts for mounting wing</li> <li>1 X STD Fertiliser adapter</li> <li>1 x Sowing wing</li> <li>4 x Cone lock nuts (2 big &amp; 2 small)</li> <li>2 x Serrated washer</li> </ul> <p><b>Options</b></p> <ul style="list-style-type: none"> <li>Liquid Nitro Plate</li> <li>Hose adapters</li> <li>Concorde leg adapter</li> <li>Contour drill leg adapter</li> </ul> <p><b>Point choice</b></p> <p>KO-8</p> <p><b>Wing Choice</b></p> <p>SANDGROPER 3 or REDDOG 3 or REDDOG 4</p>

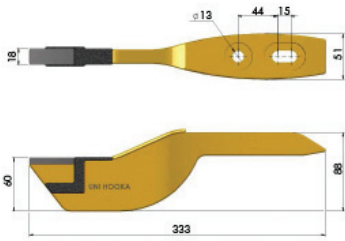
RATTLE ON SYSTEM <b>SYS RO</b>	DIMENSIONS	MAIN FEATURES
  <p><b>RED DOG 3</b></p>     	  <p><b>RED DOG 4</b></p>     	<p>The <b>RATTLE ON SYSTEM</b> combines a rattle on point, stiletto wing and fertiliser adapter. Farmers are able to customise this system by mixing and matching any of the Stiletto wings with any one of our rattle on points.</p> <p>Designed for use with curved or flat point mount (Flexi-Coil, Morris, John Deere, Borgault, Gason and Horwood Bagshaw).</p> <p><b>The RO-7 System contains</b></p> <ul style="list-style-type: none"> <li>1 x Point</li> <li>2 x Bolts for mounting to tyne</li> <li>2 x Bolts for mounting wing</li> <li>1 x Fertiliser adapter</li> <li>1 x Sowing wing</li> <li>2 x Cone lock nuts</li> <li>2 x Serrated washer</li> </ul> <p><b>Options</b></p> <ul style="list-style-type: none"> <li>Liquid Nitro Plate</li> <li>Hose adapters</li> <li>Concorde leg adapter</li> <li>Contour drill leg adapter</li> </ul> <p><b>Point choice</b></p> <p>UNI or STD, 35 or HOOKA</p> <p><b>Wing Choice</b></p> <p>SANDGROPER 3 or REDDOG 3 or REDDOG 4</p> <p><b>SANDGROPER 3</b></p>     



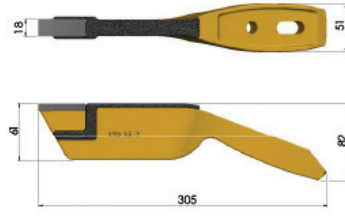

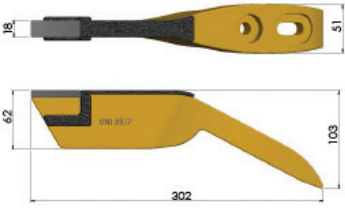
PRICES EXCLUDE GST

# STILETTO SEEDING SYSTEMS

UNI HOOKA UNIHOOKA	DIMENSIONS	MAIN FEATURES
		<p>Our unique point that combines the easy pulling of a 45° point and the reduced throw of a 35° point together with the tapered mount results in even better trash clearance (especially in couch or similar grasses) and a more precise throw of soil in the use of chemicals such as Triflurilan / Boxer Gold.</p> <ul style="list-style-type: none"> <li>• Unrivalled trash clearance with its smooth lines and unique chamfer on top to prevent snagging.</li> <li>• Recommended for 350lb (still ok with 550lb)</li> <li>• Break out machines.</li> <li>• 10 x 16 x 50 mm recessed tungsten carbide tile, backed up with overlay tungsten.</li> <li>• Fast replacement (rattle on and off).</li> <li>• Fits flat mount tyne machines such as Bourgault, Gason and Horwood Bagshaw.</li> </ul>
<p>STANDARD HOOKA STDHOOKA</p> 	<p>DIMENSIONS</p> 	<p>Our unique point that combines the easy pulling of a 45° point and the reduced throw of a 35° point together with the tapered mount results in even better trash clearance (especially in couch or similar grasses) and a more precise throw of soil in the use of chemicals such as Triflurilan / Boxer Gold.</p> <ul style="list-style-type: none"> <li>• Unrivalled trash clearance with its smooth lines and unique chamfer on top to prevent snagging.</li> <li>• Recommended for 350lb (still ok with 550lb) break out machines.</li> <li>• 10 x 16 x 50 mm recessed tungsten carbide tile, backed up with overlay tungsten.</li> <li>• Fast replacement (rattle on and off).</li> <li>• Fits all curved tyne bars - John Deere, Morris and Flexi-Coil.</li> </ul>
<p>STD RATTLE ON POINT STD 357</p> 	<p>DIMENSIONS</p> 	<p>The combination of 35° entry angle and tapered mount results in a more precise throw of soil in the use of chemicals such as triflurilan / boxer gold.</p> <ul style="list-style-type: none"> <li>• Unrivalled trash clearance with its recessed bolt holes and unique chamfer on top to prevent snagging.</li> <li>• 550 and 350 lbs hole configuration.</li> <li>• 35° entry angle</li> <li>• 10 x 16 x 50 mm recessed tungsten carbide tile, backed up with overlay tungsten.</li> <li>• Fast replacement (can use rattle gun)</li> <li>• Fits all curved tyne bars (green points) - John Deere, Morris and Flexi-Coil</li> </ul>
<p>UNI RATTLE ON POINT UNI 357/6</p> 	<p>DIMENSIONS</p> 	<p>The combination of 35° entry angle and tapered mount results in a more precise throw of soil in the use of chemicals such as Triflurilan / Boxer Gold.</p> <ul style="list-style-type: none"> <li>• Unrivalled trash clearance with its recessed bolt holes and unique chamfer on top to prevent snagging.</li> <li>• 550 and 350 lbs hole configuration.</li> <li>• 35° entry angle</li> <li>• 10 x 16 x 50 mm recessed tungsten carbide tile, backed up with overlay tungsten.</li> <li>• Fast replacement (can use rattle gun)</li> <li>• Fits all flat tyne bars Borgault, Gason and Horwood Bagshaw</li> </ul> <p>Also comes as 356 with 275mm length.</p>

PRICES EXCLUDE GST

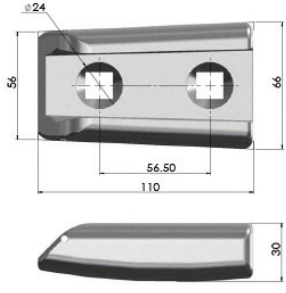
# STILETTO SEEDING SYSTEMS

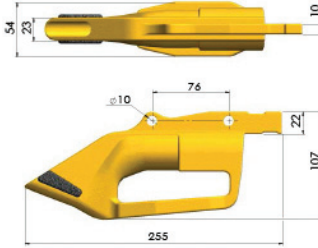
KNOCK ON POINT KO 8	DIMENSIONS	MAIN FEATURES
		<p>The Knock On Point is aimed at the farmer that wants a fast way of replacing their points. It is as simple as sliding the point into the adapter and inserting a safety pin to prevent the point being dislodged when the tyne recoils abruptly.</p> <ul style="list-style-type: none"> <li>• Unrivalled trash clearance with its smooth lines and unique chamfer on top to prevent snagging.</li> <li>• 45 degree entry angle for easier pull in tough conditions.</li> <li>• 8 x 18 x 50 mm tungsten carbide tile, backed up with overlay tungsten.</li> <li>• Fast replacement (pull pin knock out and slide new point in).</li> <li>• Fits all curved tyne bars - John Deere, Morris and Flexi-Coil.</li> </ul>
		<p>The Knock On Mount is the mounting unit for the Knock On 8 to suit 350 lbs (or 550 lbs) break out hole configuration.</p>
		<p>The Stiletto adapters are designed to hold the sowing wing and place the fertiliser. Each of the adapters have been engineered to maintain the wing level as it travels under the ground depending on the bar it is set up on.</p> <p>Designed for use with flat tyne bars (Borgault, Gason and Horwood Bagshaw).</p>
		<p>The Stiletto adapters are designed to hold the sowing wing and place the fertiliser. Each of the adapters have been engineered to maintain the wing level as it travels under the ground depending on the bar it is set up on.</p> <p>Designed for use with curved tyne bars (John Deere 1830, Morris and Flexi-Coil).</p>

PRICES EXCLUDE GST

# STILETTO SEEDING SYSTEMS

SEEDING WING SANDGROPER 3	DIMENSIONS	MAIN FEATURES
		<p>Designed for non-wetting soils ranging up to medium to heavy clay. The sloped leading edge of the wing closes the slot left by the point and creates a firm bed for the seed to be placed on. The extended bridge across the back of the wing reduces seed bounce, keeping the seed split at <b>3 inches</b> wide. This makes it the benchmark in wing seeding systems. Used in conjunction with the fertilizer adapter it can also be used in a single shoot system to place seed and fertiliser together.</p> <p><b>Suitable for sandy soils.</b></p>
		<p>Designed for use in heavy clay. The flatter underside of the wing allows better flow of clay soil while in conjunction with bedformers it creates a firm bed for seed to be placed and split at <b>3 inches</b> wide whilst still effectively closing the slot made by the point.</p> <p>Used in conjunction with the fertilizer adapter. Can also be used in single shoot system to place seed and fertiliser together.</p> <p><b>Suitable for clay soils.</b></p>
		<p>Designed for use in heavy clay. The flatter underside of the wing allows better flow of clay soil while in conjunction with bedformers it creates a firm bed for seed to be placed and split at <b>4 inches</b> wide, whilst still effectively closing the slot made by the point.</p> <p>Used in conjunction with the fertilizer adapter. Can also be used in single shoot system to place seed and fertiliser together.</p> <p><b>Suitable for clay soils.</b></p>
		<p>Stiletto Para Boot to fit the DBS and Stiletto Para Boot to fit PSS (Primary Sales Seeder).</p> <p>Advantages are all the usual Stiletto things like better seed placement and germination also the fact that there is no loss of seed to the bottom of the furrow due to the mouse holing effect caused by the standard seed closer plate.</p> <p>Better yields are achieved, because the seed is sown into uncultivated soil the seed is sitting in moisture and not where the point has dried out the soil.</p> <p>Also it has the ability to chase moisture.</p>







PRICES EXCLUDE GST

T: (08) 9362 6811

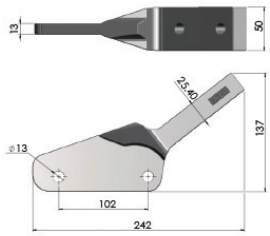
10

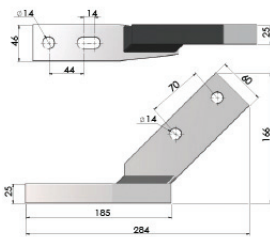
F: (08) 9361 3263

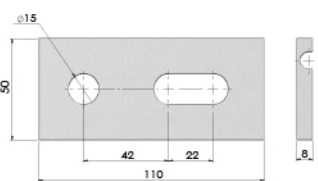
# STILETTO SEEDING SYSTEMS

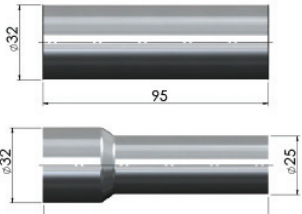
DRILL MOUND ADAPTER <b>MCDA</b>	DIMENSIONS	MAIN FEATURES
		<p>The MCDA allows you to fit the Stiletto Seeding System to the Morris Contour drill.</p>
		<p>The MCSA allows you to fit the Stiletto Seeding System to the Concord Air Hoe Drill.</p>
		<p>Liquid Nitrogen plate fits in front of the fertiliser adapter allowing the farmer to band flexi-N and other liquid products behind the knife point.</p>
		<p>Adapter to Fit 25mm (or 32mm) ID hose.</p>

PRICES EXCLUDE GST

# STILETTO SEEDING SYSTEMS

OTHER PARTS		
BOLTS	NUTS	WASHERS
 <p><b>G8 HEX HEAD BOLT 1/2" X 3"UNC</b> Use for 25mm Tyne      Part Number: B1</p> <p><b>G8 HEX HEAD BOLT 1/2" X 3 1/4"UNC</b> Use for 25MM With Liquid Plate or 32mm Tyne Part Number: B2</p> <p><b>G8 HEX HEAD BOLT 1/2" X 3 1/2"UNC</b> Use for 32MM Tyne with Liquid Plate B3 Part Number: B3</p> <p><b>G8 HEX HEAD BOLT 3/8" X 1/2" UNC</b> Attach Wing &amp; Adaptor Together Part Number: B4</p> <p><b>COUNTERSUNK BOLT 1/2" X 3"</b> Knock-On Knife Points      Part Number: B5</p>	 <p><b>CONE LOCK NUT 1/2"</b> Use for all Knife Points Part Number: N1</p> <p><b>CONE LOCK NUT 3/8"</b> Part Number: N1</p>	 <p><b>WASHER SERATED LOCK 1/2"</b> Use for all Knife Points      Part Number: W1</p> <p><b>WASHER SPRING 1/2"</b>      Part Number: W2</p> <p><b>WASHER FLAT 1/2"</b>      Part Number: W3</p>



PRICES EXCLUDE GST



# STILETTO SEEDING SYSTEMS

PART NO	DESCRIPTION	USE
WING SANDGROPER 3	3" SEEDER WING SPLITTER	SANDY SOILS
WING REDDOG 3	3" SEEDER WING SPLITTER	CLAY SOILS
WING REDDOG 4	4" SEEDER WING SPLITTER	CLAY SOILS
PARAWING DBS	4" SEEDER WING WITH 550MM STAINLESS STEEL TUBE	DBS TYNE
PARAWING PSS		

HA-25	HOSE ADAPTER REDUCED	TO FIT 25MM HOSE
HA-32	HOSE ADAPTER STRAIGHT	TO FIT 32MM HOSE

ADP UNI	FERTILISER ADAPTER UNIVERSAL	TO FIT FLAT TYNE
ADP JD	FERTILISER ADAPTER JD	TO FIT JD 1820 TYNE
ADP FC	FERTILISER ADAPTER FC	TO FIT JD 1830 & OTHER CURVED TYNES
MCDA	MORRIS CI SHANK ADAPTER	MORRIS CONTOUR SHANK
MCSA	CONCORD SHANK ADAPTER	

STD357	KNIFE POINT	18MM X 7" STANDARD RATTLE ON WITH TILE & TUNGSTEN COATING
UNI357/6	KNIFE POINT	18MM X 7" UNIVERSAL RATTLE ON WITH TILE & TUNGSTEN COATING
STDHOOKA	KNIFE POINT	18MM X 7" HOOKA STANDARD RATTLE ON WITH TILE & TUNGSTEN COATING
UNIHOOKA	KNIFE POINT	18MM X 7" HOOKA UNI RATTLE ON WITH TILE & TUNGSTEN COATING
KO-8	KNIFE POINT	18MM X 8" KNOCK ON 8"
KOM 350	KNIFE POINT MOUNT FOR KNOCK ON 8"	350 BREAKOUT
KOM 550	KNIFE POINT MOUNT FOR KNOCK ON 8"	550 BREAKOUT
SPACERS	LIQUID NITRO PLATE WITH 6MM POLY TUBE	

SYS KO	INCLUDES A SEEDER WING, HOSE ADAPTER, ADAPTER & KNOCK ON KNIFE POINT & MOUNT	
SYS RO	INCLUDES A SEEDER WING, HOSE ADAPTER, ADAPTER & RATTLE ON KNIFE POINT	

**ALL SYSTEMS INCLUDE CONE LOCK NUTS, LOCK WASHERS AND BOLTS TO FIT KNIFE POINTS  
ALL WING ADAPTERS COME WITH GRADE 8 BOLTS AND LOCK NUTS TO FIT THEM TOGETHER**

B1	G8 HEX HEAD BOLT - 1/2" X 3" UNC	25MM TYNE
B2	G8 HEX HEAD BOLT - 1/2" X 3 1/4" UNC	25MM TYNE WITH LIQUID PLATE OR 32MM TYNE
B3	G8 HEX HEAD BOLT - 1/2" X 3 1/2" UNC	32MM TYNE WITH LIQUID PLATE
B4	G8 HEX HEAD BOLT - 3/8" X 1 1/2" UNC	ATTACH WING & ADAPTER TOGETHER
B5	CONTERSUNK BOLT 1/2" X 3"	KNOCK ON KNIFE POINTS
N1	CONE LOCK NUT 1/2"	ALL KNIFE POINTS
N2	CONE LOCK NUT 3/8"	ATTACH WING & ADAPTER TOGETHER
W1	WASHER SEPARATED LOCK 1/2"	ALL KNIFE POINTS
W2	WASHER SPRING 1/2"	
W3	WASHER FLAT 1/2"	
PT6	6MM X 400MM BLACK POLY TUBE	LIQUID PLATES

PRICES EXCLUDE GST

**T: (08) 9362 6811**

**13**

**F: (08) 9361 3263**

# SLOT MATE SYSTEM

	FEATURES	BENEFITS
	<ul style="list-style-type: none"> <li>• Quick change adaptor that can stay on your bar for life</li> <li>• Solid secure point holder</li> <li>• Huge range of points and options to suit your conditions, seeding bar and soil types.</li> </ul>	<ul style="list-style-type: none"> <li>• Great value points</li> <li>• Hassle free efficient seeding</li> <li>• Less time changing points</li> </ul>

## TUNGSTEN OPTIONS

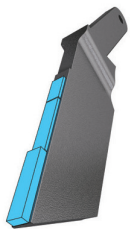

### 12mm

The common 12mm wide point for lowest soil throw and easiest pulling.

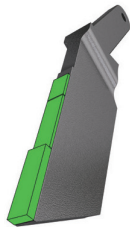

### 15mm

15mm wide tungsten for extra wear life.



### SLL

The Super Long Life with extra thick 'spear angled' tungsten and hardfacing on the side.

## UPGRADES

### Hardfacing



PT-UPH

\$12

Adds life by improving side and back wear, particularly in abrasive soils or wet seeding.

### Liquid Tube Holder – Nut



PT-UPN

\$3.50

Simple nut welded to holder 6mm liquid tube. Other sizes available on request.

### Liquid Tube Holder – Block



PT-UPB

\$19

More secure holder than the nut, suit 6mm tube.

### Side Plates



PT-UPS

\$25

For double shoot set ups, deflects soil away from the fertiliser drop zone.

Images and product information supplied by Maxipoint

PRICES EXCLUDE GST



# SLOT MATE SYSTEM

**Slot Mate Vertical 12mm**



Depth: 7" Angle: 70°

PT-1SMV

**\$68**

**Slot Mate Vertical 15mm**



Depth: 7" Angle: 70°

PT-1SMV5

**\$72**

**Slot Mate Vertical SLL**



Depth: 7" Angle: 70°

PT-1SMV8

**\$92**

**Slot Mate V Short 12mm**



Depth: 5" Angle: 70°

PT-1SMVC

**\$68**

**Slot Mate V Short 15mm**



Depth: 5" Angle: 70°

PT-1SMV5C

**\$72**

**Slot Mate Straight 12mm**



Depth: 7" Angle: 60°

PT-1SMS

**\$68**

**Slot Mate Straight 15mm**



Depth: 7" Angle: 60°

PT-1SMS5

**\$72**

**Slot Mate Straight SLL**



Depth: 7" Angle: 60°

PT-1SMS8

**\$92**

**Slot Mate Dyna**



Depth: 6" Angle: 65°

PT-1SMD

**\$68**

**Slot Mate Flexi**



Depth: 6" Wing: 60mm

PT-1SMF

**\$88**

**Slot Mate Razor 15mm**



PT-1085

**\$82**

**Slot Mate Razor SLL**



PT-1086

**\$102**

**Slot Mate Ezi**



PT-SMEA

**\$24**

**Slot Mate Adaptor 7/16"**



PT-1SMA7/16

**\$14**

**Slot Mate Adaptor 1/2"**



PT-1SMA1/2

**\$14**

**Slot Mate Sweep 4"**



PT-2020

**\$63**

**Slot Mate Sweep 6"**



PT-2021

**\$65**

**Slot Mate Sweep 8"**



PT-2022

**\$69**

**Slot Mate Sweep 10"**



PT-2023

**\$69**

**Slot Mate Sweep 12"**



PT-2024

**\$72**

**Trash Guard**



PT-2002

**\$30**

**Lynch Pin**



FA-0802

**\$1.00**

**HD Lynch Pin**



FA-0803

**\$2.00**

Images and product information supplied by Maxipoint

PRICES EXCLUDE GST

# BOLT ON WEDGES



We only use premium grade tungsten carbide on high quality castings, all put together in our factory in Perth, WA.

**We aim to supply points that are:**

- Long Lasting
- Durable
- Excellent Value For Money

**Knife point system for cultivators including:**

- All C-Shank Machines
- Gason
- Horwood
- Simplicity
- Ezee-On
- John Shearer
- Flexicoil Edge On
- and more...

**Dyna Blade Curved**



Depth: 6" Angle: 65°

PT-112A

\$77

**Dyna Blade Flat**



Depth: 6" Angle: 65°

PT-112B

\$77

**Ezi Blade Vertical**



Depth: 6" Angle: 65°

PT-113V

\$73

**Ezi Blade Vertical Short**



Depth: 4" Angle: 65°

PT-113VC

\$73

**Ezi Blade Straight**



Depth: 6" Angle: 65°

PT-113S

\$73

**Ezi Blade Straight Short**



Depth: 4" Angle: 65°

PT-113SC

\$73

**2 Bolt Curved Adaptor**



PT-1E48

\$39

**Wedge Adaptor**



PT-1EWA

\$33

**Wedge 1/2 x 45**



PT-1MW1

\$22

**Wedge 7/16 x 45**



PT-1MW2

\$22

**Wedge 1/2 x 57**



PT-1MW3

\$22

Images and product information supplied by Maxipoint

PRICES EXCLUDE GST

## EZY FIT SYSTEM

### Ezi Ripper



Depth: 4"  
PT-10ER

\$60

### Ezi Seeder



Depth: 4" Wing: 60mm  
PT-10ES

\$74

### Deep Ripper



Depth: 5"  
PT-10DR

\$68

### Deep Seeder



Depth: 5" Wing: 60mm  
PT-10DS

\$75

### Roll Pin



PT-10EP

\$1.00

## SINGLE BOLT ON

### Maxi Seeder

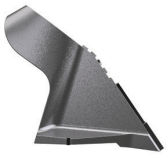

Bolt: 7/16" Wing: 45mm  
PT-1001

\$67

### Maxi Knife



Bolt: 7/16"  
PT-1002

\$59

### Maxi Plus

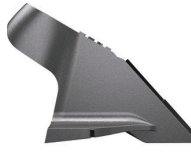

Bolt: 7/16" Wing: 60mm  
PT-1004

\$74

### 7/16 x 2 1/4



FA-0315

\$1.40

### 7/16" Nyloc Nut



FA-0409

\$0.40

### 1 Bolt Ripper



Bolt: 7/16"  
PT-1007

\$60

### Scari Ripper



Bolt: 1/2"  
PT-1009

\$69

### Scari Ripper Winged



Bolt: 1/2" Wing: 60mm  
PT-1011

\$80

### 1/2 x 2 1/4



FA-0321

\$1.40

### 1/2" Nyloc Nut



FA-0410

\$0.40

## SEED DRILLS

### Pasture Point



PT-1014

\$64

### Pasture Point Duncan



PT-1015

\$64

### Pasture Point Knife



PT-1022

\$54

### M10 x 60 Hex Bolt



FA-0116

\$0.60

### M10 Nyloc Nut



FA-0402

\$0.30

Images and product information supplied by Maxipoint

PRICES EXCLUDE GST

T: (08) 9362 6811

17

F: (08) 9361 3263

# SEED BOOT CULTIVATORS



Single Shoot Paired Row



Double Shoot  
Single Row 50mm Backshoot

**SEED YOUR WAY  
WITH MAXIPOINT'S  
INTERCHANGEABLE  
SYSTEMS**

**ACCURATE INPUT CONTROL**

**DURABLE DESIGNS  
FOR THE TOUGHEST  
CONDITIONS**

**Systems available for:**  
Single Shoot / Double Shoot + Liquid Fertiliser + Soil Wetter

Single Shoot Single Row

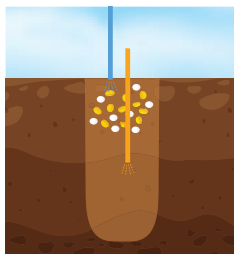

Single Shoot Paired Row

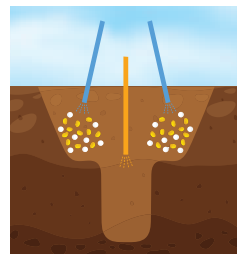

Double Shoot Single Row

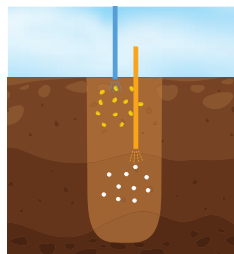

Double Shoot Paired Row

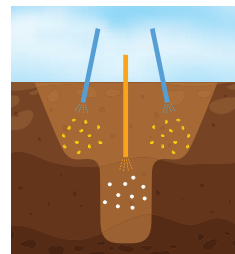

Double Shoot Side Banded

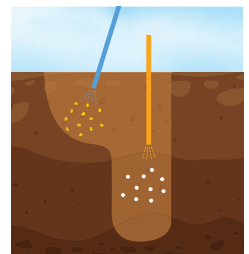

**Key:**

- Seed
- Fertiliser
- Liquid Fertiliser
- Soil Wetter

## 7 Seed Placement Options

- Single Row Narrow Closer Plates (20mm & 30mm Closer Plate):**  
For heavy soil types.
- Single Row 50mm Closer Plate:**  
Most common for Australia seeding conditions.
- Paired Row 40mm:** 40mm spacing will give a wider seeding row.
- Paired Row 70mm:** 70mm Spacing will give 2 distinct rows.
- Side Banded:** Seed placement on shoulder of furrow.
- Single Row Flexible Backshoot:** For low breakout bars, or as conditions dictate.

**Cultivator Seed Boots For**

- C Shank 1/2"
- C Shank 7/16"
- Horwood Curved
- Horwood Straight
- Gason
- Simplicity
- Flexicoil Edge On

**Precision Seeders/Other**

- Bourgault Paralink**
- Horsch Tyne**
- Case Concord**  
Page 11
- Morris**  
Page 12
- Ausplow**  
Page 13
- Conserva / JD-1870**  
Page 14
- Seed Hawk**  
In development

Images and product information supplied by Maxipoint

PRICES EXCLUDE GST

# SEED BOOT CULTIVATORS

## Single Shoot

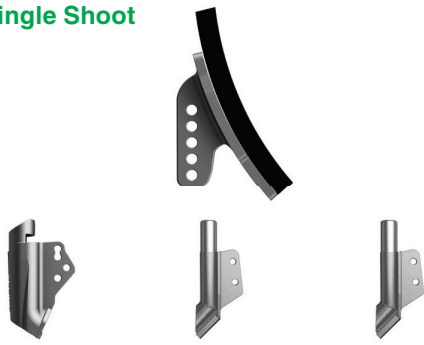

## Double Shoot

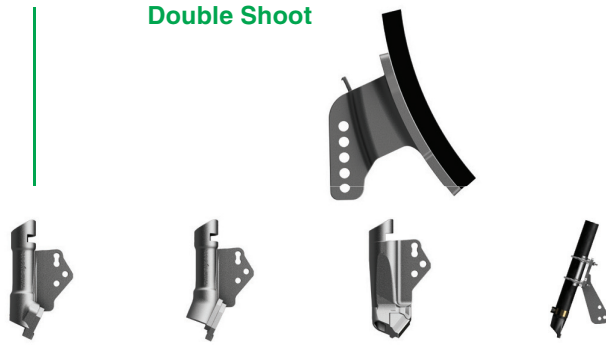

### Single Shoot Kit With

50mm Single Row Backshoot	SB-1230	\$118
20mm Single Row Backshoot	SB-1237	\$122
30mm Single Row Backshoot	SB-1231	\$118
40mm Paired Row Backshoot	SB-1232	\$141
70mm Paired Row Backshoot	SB-1233	\$141
Side Banded Backshoot	SB-1236	\$141
Flexi Backshoot	SB-1234	\$149

### Double Shoot Kit With

50mm Single Row Backshoot	DB-1220	\$144
20mm Single Row Backshoot	DB-1237	\$148
30mm Single Row Backshoot	DB-1221	\$144
40mm Paired Row Backshoot	DB-1222	\$167
70mm Paired Row Backshoot	DB-1223	\$167
Side Banded Backshoot	DB-1236	\$167
Flexi Backshoot	DB-1224	\$175

### Bar Selector

- C Shank 1/2"
- C Shank 7/6"
- Horwood Straight
- Simplicity
- Horwood Curved
- Gason
- Flexicoil Edge On

## Individual Parts

### Single Shoot Tyne Frame



SB-0231 \$62

### Double Shoot Tyne Frame



DB-0220 \$68

Please note the tyne frame part numbers SB-0231 and DB-0220 are for Tyne Frames to suit C-Shank cultivator tynes.

If you have an edge on tyne, or any tyne other than a C-Shank, you must indicate your shank type on your order.

We make tyne frames to suit the following tynes: Horwood Curved, Horwood Straight, Gason, Simplicity, Flexicoil Edge-On, John Shearer and more.

These tyne frames are also supplied with a special U-bolt to suit. If unsure we welcome you to call or email us to clarify any details.

### 20mm Narrow



BS-1229 \$95

### 30mm Single Row



BS-1241 \$92

### 50mm Single Row



BS-1242 \$92

### 40mm Paired Row

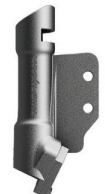

BS-1243 \$108

### 70mm Paired Row



BS-1244 \$108

### Side Banded



BS-1250 \$105

### Flexi Backshoot



BS-1280 \$120

### Closer Plate 50mm

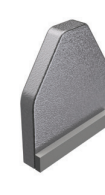

BS-0244 \$30

### Closer Plate 30mm

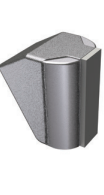

BS-0239 \$33

### Closer 40mm Paired

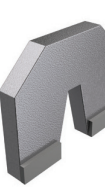

BS-0246 \$35

### Closer 70mm Paired



BS-0247 \$35

### Flexi Closer



FB-0255 \$48

Images and product information supplied by Maxipoint

PRICES EXCLUDE GST



# INLINE SERIES

	FEATURES	STRONG & DURABLE
	<ul style="list-style-type: none"> <li>• Accurate seed and deep banded fertiliser placement</li> <li>• Liquid fert compatible</li> <li>• Durable and hard wearing</li> <li>• Simple set up.</li> </ul>	<p>The Inline Series boots are protected with tungsten grit infused hardface welding.</p> <p>It's a versatile wear protection method that conforms to curves and irregular shaped castings far better than tungsten tiles, and can withstand sharp impact without cracking.</p>

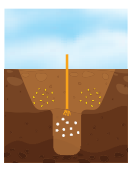

**Curved – Suit C-Shank** 

**Flat – Suit Edge On** 



**Paired Row** IS-1006 **\$210**

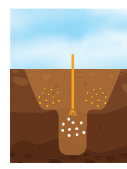

**Paired Row** IS-1001 **\$210**

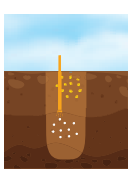

**Single Row** IS-1008 **\$210**

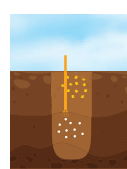

**Single Row** IS-1003 **\$210**

**Side Banded** IS-1007 **\$220**

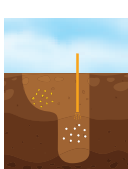
**Side Banded** IS-1002 **\$220**

Images and product information supplied by Maxipoint

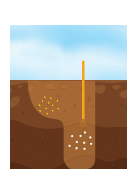
PRICES EXCLUDE GST

# BOURGAULT PARALINK



## Bourgault Paralink Seeding Kit

Kit Includes Point, Main Bracket, Backshoot, Fasteners

PC-3001 **\$286**

**When ordering please specify**

Backshoot:

Point:

Our Bourgault Paralink seeding kit is a proven and effective seeding system designed to optimise the PLX/PLS row units accurate depth control and packing pressure.

Set seed depth with 3 height settings

6 backshoots to choose for desired seed placement

Deep banded liquid & granular fertiliser placement for double shoot

Height adjustable point

Different point options to suit your conditions & seeding system

## Individual Parts

### CK Point



PT-1026

**\$92**

### CK Point – Liquid Tube



PT-1027

**\$102**

### CK Point – Liquid Block



PT-1028

**\$102**

### CK Point with Side Plates



PT-1029

**\$102**

### CK Point SLL



PT-1038

**\$112**

### 1/4" Push Fitting



FA-0808

**\$7.65**

### 20mm Narrow



BS-1229

**\$95**

### 30mm Single Row



BS-1241

**\$92**

### 50mm Single Row



BS-1242

**\$92**

### 40mm Paired Row



BS-1243

**\$108**

### 70mm Paired Row



BS-1244

**\$108**

### Side Banded



BS-1250

**\$105**

**Knife Points to suit new Bourgault PLDS Openers**

### PLDS Point 12mm



PT-1040

**\$145**

### PLDS Point 15mm



PT-1041

**\$150**

### PLDS Point SLL



PT-1042

**\$175**

### Horsch Tyne



PC-5002

**\$375**

### Case Concord



PC-4001

**\$260**

For point/backshoot options and further details please visit: [agriparts.com.au](http://agriparts.com.au)

Images and product information supplied by Maxipoint

PRICES EXCLUDE GST

**T: (08) 9362 6811**

**21**

**F: (08) 9361 3263**

# MORRIS QUANTUM SEEDING KIT



<b>Single Shoot</b>	PC-2001	<b>\$310</b>
<b>Double Shoot</b>	PC-2002	<b>\$360</b>

**When ordering please specify**

Backshoot: \_\_\_\_\_

Point: \_\_\_\_\_

Our Morris Quantum seeding kit is a proven and effective seeding system designed to optimise the updated Quantum row units accurate depth control and packing pressure, and the tungsten edge on the point is flat as per Morris specification.

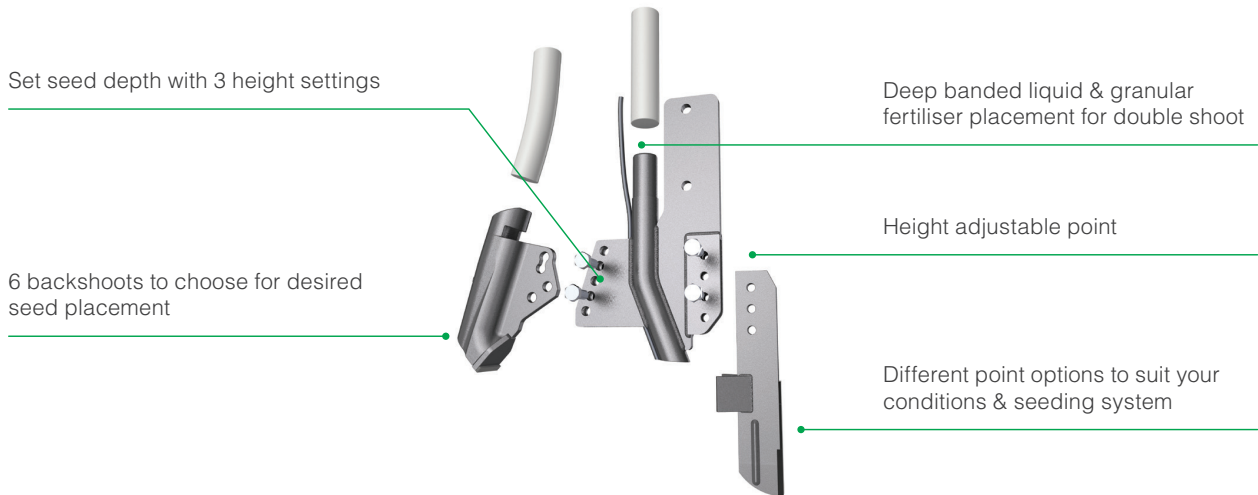

## Individual Parts

<p><b>CT Point</b></p>  <p>Suit C2 PT-1030 <b>\$68</b></p>	<p><b>CT Point Hardfaced</b></p>  <p>Suit C2 PT-1031 <b>\$78</b></p>	<p><b>CTQ Point</b></p>  <p>Suit Quantum PT-1034 <b>\$74</b></p>	<p><b>CTQ Point SLL</b></p>  <p>Suit Quantum PT-1036 <b>\$94</b></p>	<p><b>Morris C1</b></p>  <p>PT-1035 <b>\$120</b></p>	<p><b>Morris C2</b></p>  <p>PT-1060 <b>\$120</b></p>
<p><b>20mm Narrow</b></p>  <p>BS-1229 <b>\$95</b></p>	<p><b>30mm Single Row</b></p>  <p>BS-1230 <b>\$92</b></p>	<p><b>50mm Single Row</b></p>  <p>BS-1240 <b>\$92</b></p>	<p><b>40mm Paired Row</b></p>  <p>BS-1260 <b>\$108</b></p>	<p><b>70mm Paired Row</b></p>  <p>BS-1262 <b>\$108</b></p>	<p><b>Side Banded</b></p>  <p>BS-1255 <b>\$105</b></p>

Images and product information supplied by Maxipoint

PRICES EXCLUDE GST



# AUSPLOW

	FEATURES	BENEFITS
	<ul style="list-style-type: none"> <li>• Super Heavy Duty quick change point system</li> <li>• Highly secure point system, don't lose points or adaptors</li> <li>• Featuring a wide range of points with various tungsten and hardfacing options.</li> </ul>	<ul style="list-style-type: none"> <li>• Save \$\$ on points to suit Ausplow bars with the Maxipoint Slot Mate A range</li> <li>• Excellent \$\$/ha value</li> <li>• Save time changing points</li> <li>• Set and forget. You can rely on the Slot Mate A to get the job done.</li> </ul>

## Individual Parts

### Quick Change Adaptor



PT-1070 **\$15.00**

### Slot Mate A 6"



PT-1071 **\$70.00**

### Slot Mate A 6" SLL



PT-1076 **\$90.00**

### Slot Mate A 7"



PT-1072 **\$70.00**

### Slot Mate A 7" SLL



PT-1077 **\$90.00**

### Slot Mate A 8"



PT-1073 **\$70.00**

## Upgrades

### Hardfacing



PT-UPH **\$12.00**

### Liquid Tube Holder - Nut

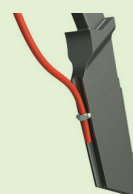

PT-UPN **\$3.50**

### Liquid Tube Holder - Block

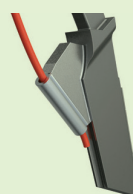

PT-UPS **\$19.00**

### DB Ripper 7"



Bolt on  
PT-115A **\$80.00**

### DB Ripper 8"



Bolt on  
PT-115B **\$82.00**

### Sweep 10"



PT-2029 **\$57.00**

### Sweep 12"



PT-2030 **\$80.00**

### Trash Guard



PT-2008 **\$30.00**

### Slot Mate A 8" Winged



PT-1082 **\$110.00**

### Slot Mate A 8" SLL



PT-1078 **\$90.00**

### Slot Mate A 6" Winged



PT-1080 **\$110.00**

### Slot Mate A 7" Winged













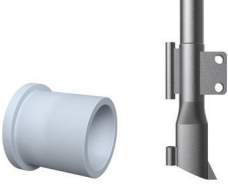







PT-1081 **\$110.00**

Images and product information supplied by Maxipoint

PRICES EXCLUDE GST

# CONSERVA PAK / JD 1870

Points	Boots	Wheels	Parts
 <p>Premium knife point in 3 tungsten options. With 'shank guard' for added shank protection. Roll pins sold separately.</p>	 <p><b>3 Seed Placement Options</b> <b>20mm:</b> Narrow closer plate, inline with point, for minimal soil disturbance. <b>50mm:</b> Common 50mm wide closer plate, inline with point for best seed bed preparation in most soil types. <b>Paired Row:</b> Split row seeding with 40mm distance between rows.</p>	 <p>Press wheels come with a bush kit to fit onto JD1870 axles. Quick and easy to install. Point and seed boot settings to do need to change after installing Maxipoint press wheels.</p>	 <p>We have a range of spare parts we have developed with and for JD1870 owners over the past decade.</p> <ul style="list-style-type: none"> <li>• Bushes</li> <li>• Fertiliser Shoot</li> <li>• Tungsten tipped wheel scraper</li> <li>• Pins, Fasteners etc</li> </ul>

<p><b>Conserva Point</b></p>  <p>PT-1006 <b>\$78</b></p>	<p><b>Conserva Point Hardfaced</b></p>  <p>PT-1019 <b>\$88</b></p>	<p><b>Conserva Point SLL</b></p>  <p>PT-1020 <b>\$98</b></p>	<p><b>Sweep 12"</b></p>  <p>PT-2025 <b>\$88</b></p>	<p><b>Roll Pin 3/8"</b></p>  <p>PT-1008 <b>\$1.20</b></p>
<p><b>Single Row 50mm</b></p>  <p>BS-1287 <b>\$70</b></p>	<p><b>Single Row 20mm</b></p>  <p>BS-1288 <b>\$70</b></p>	<p><b>Paired Row</b></p>  <p>BS-1285 <b>\$85</b></p>	<p><b>Fertiliser Shoot</b></p>  <p>BS-1286 <b>\$65</b></p>	<p><b>Bolt/Nut</b></p>  <p>FA-0300/FA-0408 <b>\$1/\$0.40</b></p>
<p><b>Press Wheel – V – Profile</b></p>  <p>SP-1105 <b>\$255</b></p> <p>Includes bush kit to suit Cpak axle.</p>	<p><b>Press Wheel – Flat</b></p>  <p>SP-1107 <b>\$255</b></p> <p>Includes bush kit to suit Cpak axle.</p>	<p><b>Press Wheel Scraper</b></p>  <p>SS-1218 <b>\$20</b></p>	<p><b>Suit Opener Tyne</b></p>  <p>SS-1219 <b>\$26</b></p>	<p><b>Suit Seeding Tyne</b></p>  <p>SS-1220 <b>\$26</b></p>

Images and product information supplied by Maxipoint

PRICES EXCLUDE GST

# COULTERS





## Twin Disc Coupler System

CS-1300 **\$1,400**

- Available in 9/10/12 inch spacing
- Single coulters are available if required
- For mounting frame advice please contact us
- Wider spacings available on request.

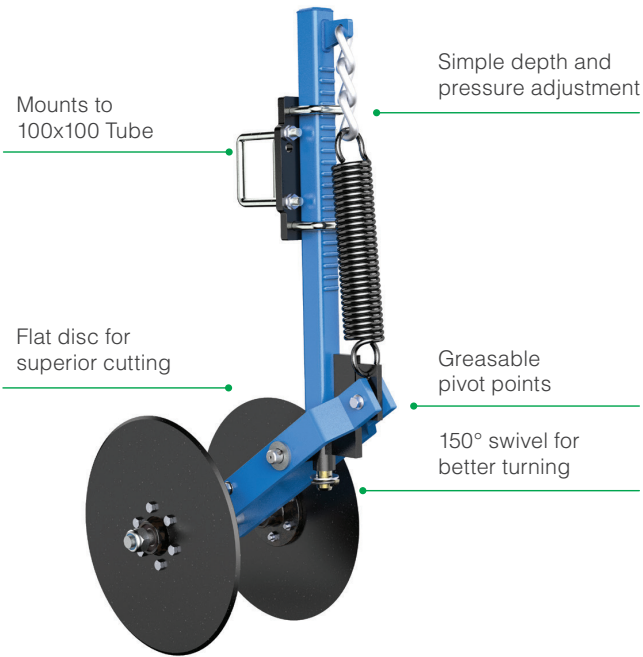
**Seed into the heaviest stubble with no build up.**



ORDER NO	DESCRIPTION	MAX PRESSURE RATING	AVAILABLE DISC SIZES	PRICE
<b>K-HART / YETTER COULTERS</b>				
CKH1650	 K-HART COULTER 2 1/4 DIA SHANK FOR STRENGTH AND FAST VERTICLE ADJUSTMENT SEALED TAPERED ROLLER BEARINGS	1300 LBS		
CY2995CL	 YETTER GENERATION 3 COULTER IMPROVES RESIDUE FLOW	1300 LBS	17, 18, 20 INCH	

Images and product information supplied by Maxipoint

PRICES EXCLUDE GST

# COULTERS

ORDER NO	DESCRIPTION	MAX PRESSURE RATING	AVAILABLE DISC SIZES
<b>K-HART YETTER COULTERS</b>			
CY2995CR 	YETTER GENERATION 3 COULTER IMPROVES RESIDUE FLOW	1300 LBS	
CY2930 	YETTER ECONOMY VERSION CUTS MELON VINES, WIRE WEED AND STRAW	1300 LBS	17, 18, 20 INCH
ORDER NO	DESCRIPTION		
<b>DOUBLE DISC OPENERS</b>			
OKH3612LBA	K-HART LOW PROFILE DOUBLE DISC OPENER LEFT HAND BRACED ARM, SUITS MOST COMBINES		
OKH3612LQA	K-HART LOW PROFILE DOUBLE DISC OPENER LEFT HAND QUICK ADJUST, SUITS MOST COMBINES		
OKH3612RBA	K-HART LOW PROFILE DOUBLE DISC OPENER RIGHT HAND BRACED ARM, SUITS MOST COMBINES		
OKH3612RQA	K-HART LOW PROFILE DOUBLE DISC OPENER RIGHT HAND QUICK ADJUST, SUITS MOST COMBINES		
OKH4612LQA	K-HART PARALLELOGRAM DOUBLE DISC OPENER LEFT HAND WITH QUICK ADJUST PRESS WHEEL, OFFERS MINIMAL SOIL AND RESIDUE DISTURBANCE ACCURATE SEED PLACEMENT		
OKH4612RQA	K-HART PARALLELOGRAM DOUBLE DISC OPENER RIGHT HAND WITH QUICK ADJUST PRESS WHEEL, OFFERS MINIMAL SOIL AND RESIDUE DISTURBANCE ACCURATE SEED PLACEMENT		

COULTERS ARE IDEAL FOR IMPROVING TRASH FLOW ON SEEDING EQUIPMENT

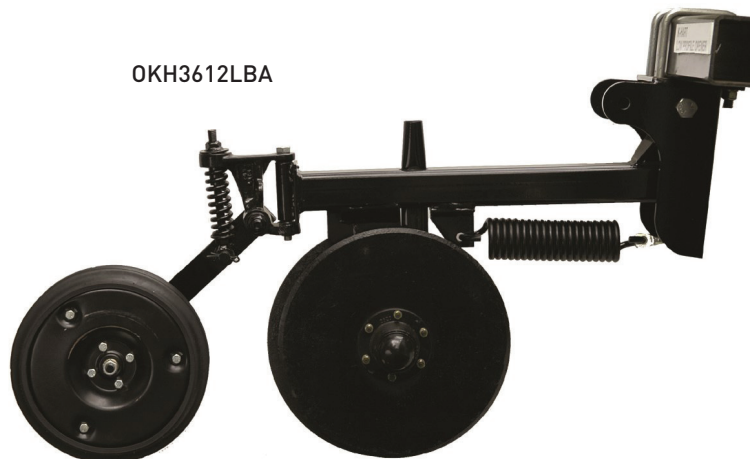

PRICES EXCLUDE GST

# SINGLE PRESS WHEEL SYSTEM



Square Profile	SS-1202	\$390
V Profile	SS-1202	\$390

## Features

- Grease free hubs
- No tools to remove wheel
- 2 Common tyre profiles for most soil types
- Mount bars to suit all air seeders.

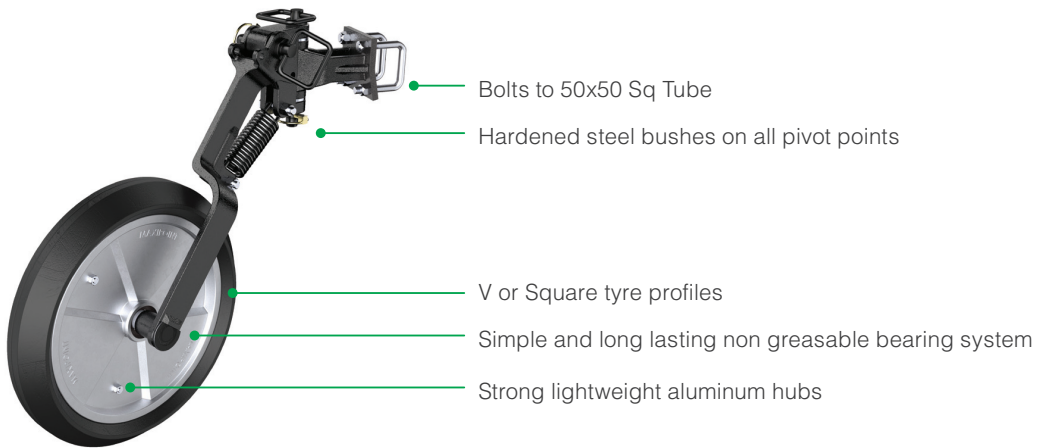

### Wheel Only – V Profile



SP-1100

\$245

### Wheel Only – Square Profile



SP-1101

\$245

### Extension Bar Kit



SS-0110

\$295

### Vertical Bar Kit



SS-0109

\$95



Images and product information supplied by Maxipoint

PRICES EXCLUDE GST

T: (08) 9362 6811

27

F: (08) 9361 3263

# PRESSWHEELS

ORDER NO	DESCRIPTION	TYRE SIZE
<b>K-HART PRESS WHEELS</b>		
PS50	PRESSWHEEL SINGLE AXLE	
PWA50	PRESSWHEEL TANDEM WALKING AXLE	
PD50	PRESSWHEEL FIXED DOUBLE	

<b>K-HART PRESS WHEEL SPARES</b>		
PWO313VT	TYRE ONLY	3 X 13 INCH V STYLE
PWO414VT	TYRE ONLY	4 X 14 INCH V STYLE
PWO313FT	TYRE ONLY	3 X 13 INCH FLAT STYLE
PWO416FT	TYRE ONLY	4 X 16 INCH FLAT STYLE
PWO316VT	TYRE ONLY	4 X 16 INCH V STYLE
PWO316FT	TYRE ONLY	4 X 16 INCH FLAT STYLE
PTA490	TRAILING ARM	NA

## K-HART PRESSWHEELS



PWA50

PD50

### Features:

- Precise row and seed packing, increases moisture retention.
- Swivel brackets, no dragging on turns.
- High grade rubber semi or pneumatic tyres.

Attach press wheels to most seeders telescope in and out, adjust up and down.

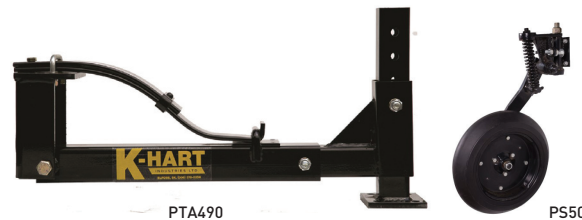

PTA490

PS50

ORDER NO	DESCRIPTION	SUITS
<b>FORWARD FARMING PRESSWHEEL</b>		
FF40054	PRESSWHEEL COMPLETE	FORWARD FARMING ASSY
FF40055	RUBBER TYRE ONLY	N/A
FF40057	ALUMINIUM RIM ONLY	N/A

### ARP PRESSWHEEL

FF40055	RUBBER TYRE ONLY	N/A
---------	------------------	-----

### SINGLE PRESS WHEEL UNIT

SS-0109	VERTICAL BAR
SS-0110	BAR EXTENSION
SS-1200	SINGLE SYSTEM INCLUDES WHEEL
SP-1100	WHEEL ONLY

### TRIPLE SYSTEM

TS-1300	3-WHEEL
TS-1500	5-WHEEL
TS-1101	PRESS WHEEL MOUNTING FRAMEWORK



SP



PP



FF40054

PRICES EXCLUDE GST

# SEED BRAKES



## Features

- **Minimise seed damage.** The seed brake uses a spiral system to slow seed flow: there are no baffles for the seeds to hit against
- **Lower cost AIRGUARD.** Seed Brakes are competitively priced making it an affordable investment
- **Deliver durability.** The UV protected plastic withstands harsh weather conditions
- **Reduce seed waste.** Controlled airflow eliminates seed bounce and seed soil mixing
- **Improve yield.** With optimum seed and fertiliser placement
- **Prevent plugging.** Modify airflow to match your specific type of opener.

## Benefits

AIRGUARD Seed Brakes are designed to help you achieve consistent optimum air flow across every opener on your air drill to achieve perfect seed and fertiliser placement. Controlled by a series of washers at the exhaust port, the adjustable air speed allows you to match your specific type of opener and achieve more efficiency with no seed bounce.

## Individual Parts

38mm Seed Brake – Stainless



BS-7360

\$117

32mm Seed Brake – Plastic



BS-7330

\$47

38mm Seed Brake – Plastic



BS-7340

\$53

Full Exhaust Seed Brake – Stainless



BS-7350

\$47

Exhaust Port Kit



BS-7336

\$15

Adaptor Kit for BS-7340/BS-7360 – 32-38mm



BS-7344

\$9

Wind Meter



BS-7400

\$50



Images and product information supplied by Maxipoint

PRICES EXCLUDE GST

# BLOCKAGE PREVENTION SYSTEMS

## Build Your Blockage Prevention System Checklist

(\*Required)

<input type="checkbox"/>	<b>1. Main Radiator Assembly*</b>	BS-7650	<b>\$3,451</b>		
<input type="checkbox"/>	<b>2. Bracket Selector*</b>				
<input type="checkbox"/>	Fits CNH & Flexicoil	BS-7701	<b>\$454</b>	<input type="checkbox"/>	
<input type="checkbox"/>	Fits Bourgault	BS-7711	<b>\$454</b>	<input type="checkbox"/>	
<input type="checkbox"/>	Fits Morris	BS-7721	<b>\$454</b>	<input type="checkbox"/>	
<input type="checkbox"/>	Fits John Deere 1910	BS-7731	<b>\$454</b>	<input type="checkbox"/>	
<input type="checkbox"/>	Fits John Deere Airpower	BS-7771	<b>\$454</b>	<input type="checkbox"/>	
<input type="checkbox"/>	Fits CNH – Crary Fan	BS-7881	<b>\$454</b>	<input type="checkbox"/>	
	<i>Please contact Maxipoint for more bracket options.</i>				
<input type="checkbox"/>	<b>3. Relief Kit*</b>	BS-7200	<b>\$324</b>		
<input type="checkbox"/>	<b>4. Select Aircart Hose Kit*</b>				
	<b>Hydraulic Hose with Quick Coupler</b>				
<input type="checkbox"/>	10ft <b>\$283</b>	40ft <b>\$477</b>			
<input type="checkbox"/>	15ft <b>\$318</b>	45ft <b>\$510</b>			
<input type="checkbox"/>	20ft <b>\$349</b>	50ft <b>\$540</b>			
<input type="checkbox"/>	25ft <b>\$389</b>	55ft <b>\$574</b>			
<input type="checkbox"/>	30ft <b>\$413</b>	60ft <b>\$606</b>			
<input type="checkbox"/>	35ft <b>\$448</b>				
				<b>5. For Tow Behind Rigs</b>	
				<b>Select Seed Bar Hose Kit</b>	
				<b>Hydraulic Hose with Quick Coupler</b>	
<input type="checkbox"/>	10ft <b>\$283</b>	40ft <b>\$477</b>			
<input type="checkbox"/>	15ft <b>\$318</b>	45ft <b>\$510</b>			
<input type="checkbox"/>	20ft <b>\$349</b>	50ft <b>\$540</b>			
<input type="checkbox"/>	25ft <b>\$389</b>	55ft <b>\$574</b>			
<input type="checkbox"/>	30ft <b>\$413</b>	60ft <b>\$606</b>			
<input type="checkbox"/>	35ft <b>\$448</b>				
				<b>6. For Twin Fan Systems</b>	
				<b>3/4" Relief Kit – Tee and Hose</b>	
<input type="checkbox"/>	3/4" Relief Kit – Tee and Hose	BS-7299	<b>\$125</b>		
				<b>7. Optional</b>	
				<b>3/4" Relief Kit – Tee and Hose</b>	
<input type="checkbox"/>	Dual Snorkel Kit	BS-7676	<b>\$1,143</b>		
<input type="checkbox"/>	Universal Snorkel Mount Kit	BS-7860	<b>\$653</b>		

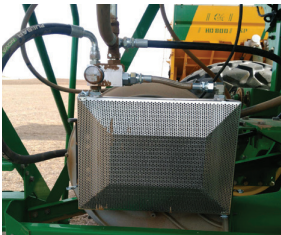

Blockage Prevention System



Blockage Prevention System



Brackets



Hydraulic Hose w/ Quick Coupler



Dual Snorkel Kit



Dual Snorkel Kit



### Keep Your Tubes Clear

Airguard Blockage Prevention systems are quick and easy to install with any air drill to deliver optimum results.

- **Seed in wet and dry conditions**  
Work in humid conditions without plugging issues.
- **Reduce humidity**  
Significantly decrease the moisture in your air drill to reduce plugging issues.
- **Low oil temperature**  
keep your oil cool and hydraulic system running efficiently.
- **Use dusty fertilisers**  
Eliminate the hassle of plugging problems with powdery fertilisers.



With Airguard

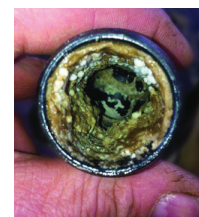

Without Airguard

Images and product information supplied by Maxipoint

PRICES EXCLUDE GST



# AIRSEEDER HEADS / RISER (RAYCOL)

ORDER NO	DESCRIPTION	INLET ID (MM)	NUMBER OF OUTLETS	OUTLET DIAMETER (MM)
<b>STAINLESS SECONDARY HEADS</b>				
SSC45532	C Type Head	45	5	32
SSC45632	C Type Head	45	6	32
SSC631025	C Type Head	63	10	25
SSC631032	C Type Head	63	10	32
SSC63632	C Type Head	63	6	32
SSC63725	C Type Head	63	7	25
SSC63732	C Type Head	63	7	32
SSC63925	C Type Head	63	9	25
SSC63932	C Type Head	63	9	32
SSD631025	D Type Head	63	10	25
SSD631125	D Type Head	63	11	25
SSD63832	D Type Head	63	8	32
SSE63632	E Type Head	63	6	32
SSE63732	E Type Head	63	7	32
SSE63832	E Type Head	63	8	32

MOST COMMONLY USED AIRSEEDER SECONDARY HEADS.  
OTHER COMBINATIONS ARE AVAILABLE ON REQUEST

ORDER NO	TYPE	DESCRIPTION
<b>SECONDARY RISERS</b>		
R176	R1	76mm R1 Riser Assembly
R163	R1	63mm R1 Riser Assembly
R150	R1	50mm R1 Riser Assembly
R145	R1	45mm R1 Riser Assembly
R276	R2	76mm R2 Riser Tube NO Bracket
R263	R2	63mm R2 Riser Tube NO Bracket
R250	R2	50mm R2 Riser Tube NO Bracket
R245	R2	45mm R2 Riser Tube NO Bracket
R376	R3	76mm R3 Adjustable Riser Assembly
R363	R3	63mm R3 Adjustable Riser Assembly
R350	R3	50mm R3 Adjustable Riser Assembly
R345	R3	45mm R3 Adjustable Riser Assembly



C

SSC63832



D

SSD631325



E

SSE631325

ORDER NO	A SIZE MM	B SIZE MM	C SIZE MM	D SIZE INCHES
<b>UBOLTS</b>				
UB42-07571	140MM	53MM	19MM	3.5
UB42-07730	155MM	33MM	16MM	4
UB42-315033	150MM	45MM	19MM	4
UB42-315034	150MM	45MM	19MM	6
UB42-07328	195MM	50MM	20MM	6
UB42-315031	230MM	50MM	19MM	7
UB42-315032	232MM	51MM	22MM	7
UB42-07547	267MM	64MM	19MM	8



R163



R263

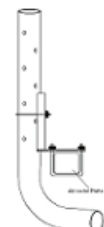

R363

ORDER NO	DESCRIPTION	ORDER NO	DESCRIPTION
<b>HIGH TENSILE CUP HEAD BOLTS</b>			
B4070	10mm X 40mm (3/8" X 1 1/2")	B2559	7/16" x 2" UNC
B4071	10mm x 45mm (3/8" x 1 3/4")	B2641	1/2" x 1 1/2" UNC
B4074	10mm x 50mm (3/8" x 2")	B2642	1/2" x 1 3/4" UNC
B4073	10mm x 65mm (3/8" x 2 1/2")	B2643	1/2" x 2" UNC
B2557	7/16" x 1 1/2" UNC	B2644	1/2" x 2 1/2" UNC
B2558	7/16" x 1 3/4" UNC		



PRICES EXCLUDE GST

# TYRESHIELD

## Prevent flat tyres on AG equipment



TyreShield® is an innovative concentrated liquid compound easily installed through the tyre valve after the removal of the tyre valve stem. After installation, simply drive the vehicle a few kilometers allowing the tyre rotation to distribute the product evenly throughout the inside of the tyre. Now, all porosity, bead, and rim leaks are sealed for the full legal life of the tyre.

Once a tyre has been treated with TyreShield® the compound creates a thin liquid film on the inside of the treated tyre which provides a barrier that maintains tyre pressure and creates a complete air tight container within the tyre and tyre rim. Optimum tyre pressure is improved for the full legal life of the tyre, and results in better tyre performance, improved fuel use, and increased safety.

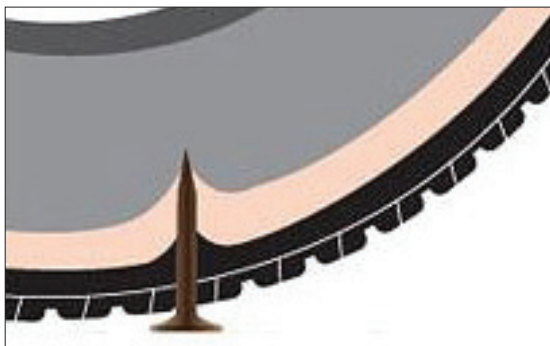

TyreShield® makes use of road & tyre friction to seal punctures while the vehicle is in motion. In the event of a puncture, the pressurized air inside the tyre trying to escape will immediately draw TyreShield® to the source of the leak and seal the hole created by the puncture, regardless if the puncturing object is removed or not. The seal is permanent, the tyre does not need to be removed and repaired, and eliminates the need for the driver to make immediate stops to check the tyre. Should a puncturing object be removed while the vehicle is stationary the tyre may lose pressure until the vehicle is in motion. For best results drive/ride the vehicle 2-5 km to ensure the leak is effectively sealed.

After installation, TyreShield® remains dormant inside the tyre until a puncture activates it.

ORDER NUMBER	DESCRIPTION	ORDER NUMBER	DESCRIPTION
<b>TYRE SHIELD</b>			
TSP2000	TYRE SHIELD 20 LITRE	TSP250	TYRE SHIELD 250ML
TSP1000	TYRE SHIELD 1 LITRE	TSP125	TYRE SHIELD 125ML
TSP500	TYRE SHIELD 500 ML		

### Recommended Minimum Tyre Doses

OFF ROAD TYRES WHICH WILL BE USED IN HIGH-RISK AREAS (3-4 PUNCTURES A DAY) CAN SAFELY INSTALL TWICE THE AMOUNT - DO NOT EXCEED ON HIGH SPEED ROAD VEHICLES

#### Typical Fill Amount (per tyre)

Bicycle 50ml road bike / 50 -75ml MTB

Motorcycle 75ml front / 125ml rear

All-Terrain Vehicle (ATV)/Large Golf Cart 150ml

Bob Cat Earth Mover 450 ml + depending on size

Scooter 50 - 75ml front / 75 - 100ml rear

Quad Bike/ Average Golf Cart 125ml

Average Truck Tyre 350 ml

#### Passenger Motor Vehicles

Tread Width Divide by 2 = Req ml

eg 225/40/18 = 225 divide by 2 = 112,5 ml per tyre

(You can round this amount down to the closest 25ml i.e 112,5 becomes 100ml)

PRICES EXCLUDE GST

**T: (08) 9362 6811**

**32**

**F: (08) 9361 3263**

# SUPA VEYAS

Wonderweld Pty Ltd is an Australian owned company located in Willowie, South Australia that manufactures the Supa-Veya Conveyor - an endless cleated belt conveyor for loading and unloading air seeder carts. The Supa-Veya Conveyor is gentle on products being conveyed and has a self-cleaning hopper to ensure less contamination.

Units range from 5.5m to 6.5m in length x 320mm wide belt x 50mm high cross cleats, but can be manufactured to your specifications.

Capacities in excess of 850kg at 45°.

Manufactured to suit a wide range of air carts including Horwood Bagshaw, Simplicity, Gason, Gyrat, Morris, Flexicoil, Ausplow and Symonds, with new makes and models being added to the list upon demand.

The Supa-Veya Conveyor whilst running smoothly is incredibly quiet to operate. The unit is also able to swing through the entire length of the bin without the hopper shifting on the ground due to the double acting armature system.

ORDER NO TOW BETWEEN	ORDER NO TOW BEHIND	ELEVATOR LENGTH	SUITS
<b>HORWOOD BAGSHAW</b>			
	SVHB4000BH	5.5 M	4000 LTR
SVHB6000BT	SVHB6000BH	6.0 M	6000 - 19,000 LTR
	SVHB21000BH	6.5 M	21,000 LTR
<b>SIMPLICITY</b>			
	SVSI6000BH	6.0 M	6000 - 9000 LTR
SVSI12000BT		6.0 M	12,000 LTR
SVSI17000BT	SVSI17000BH	6.0 M	17,000 LTR
<b>FLEXICOIL</b>			
	SVFC1720BH	6.0 M	1720 & 2320
<b>GASON</b>			
SVGS1850BT	SVGS1850BH	5.5 M	1850
SVGS1880BT	SVGS1880BH	6.0 M	1880
	SVGS2120BH	6.5 M	2120 & 2150
<b>GYRAL</b>			
	SVGY24BH	6.0 M	24 -21 STR
	SVGY30BH	6.0 M	30/40 -31 STR
SVGY30BT		6.0 M	30-38 STB
<b>AUSFLOW</b>			
	SVAP9000BH	6.0 M	9000 LTR
	SVAP10000BH	6.0 M	10,000 LTR
SVAP12000BT		6.0 M	12,000 LTR
<b>MORRIS</b>			
	SVMS7180BH	6.0 M	7180
	SVMS7240BH	6.0 M	7240
<b>OTHER</b>			
SVFE8BT		5.5 M	Forward 6 tonne & 680 Bins
SVSY8BT		5.5 M	Symonds 8000 LTR
SVSM8BT		6.0 M	8000 LTR

OTHER MODELS AVAILABLE UPON REQUEST  
 \*\*\*\*PLEASE CALL FOR INFORMATION\*\*\*\*



PRICES EXCLUDE GST

T: (08) 9362 6811

33

F: (08) 9361 3263

# AIRSEEDER REPLACEMENT CONVEYOR BELTS

ORDER NO	APPLICATION	DESCRIPTION	QTY
<b>JOHN DEERE</b>			
CM16976	667	BLACK CONVEYOR BELT CENTRAL V GUIDE	1
CM19979	547, 647, 630	GREEN PVC CONVEYOR BELT	2
<b>FORWARD ENGINEERS</b>			
CM16976	636, 660	BLACK CONVEYOR BELT WITH CENTRAL V GUIDE	1
CM19979	520, 620	GREEN PVC CONVEYOR BELT	2
FE10375-F10	640	GREEN PVC CONVEYOR BELT C/W GUIDE EITHER SIDE	1
FE10376-F10	6T, 680, 6120	GREEN PVC CONVEYOR BELT C/W GUIDE EITHER SIDE	1
<b>SUPA VEYOR CONVEYORS</b>			
SVEY55	5.5 METRE CONVEYOR	GREEN PVC CONVEYOR BELT WITH HEAVY DUTY EXTENDED CLEATS	1
SVEY6	6.0 METRE CONVEYOR	GREEN PVC CONVEYOR BELT WITH HEAVY DUTY EXTENDED CLEATS	1
SVEY65	6.5 METRE CONVEYOR	GREEN PVC CONVEYOR BELT WITH HEAVY DUTY EXTENDED CLEATS	1

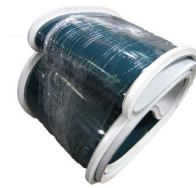

FE10376 -F10



CM16976



# AIRSEEDER HEAVY DUTY FLEXIBLE COUPLING

## AIRSEEDER COUPLING

FFCOUP6	Poly Urethane Flexible 6" Coupling
FFCOUP8	Poly Urethane Flexible 8" Coupling

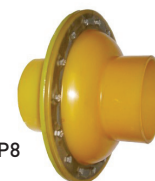

FFCOUP8

PRICES EXCLUDE GST

T: (08) 9362 6811

34

F: (08) 9361 3263

# AIRSEEDER HOSE

ORDER NO	DESCRIPTION	ID (MM)	OD (MM)
----------	-------------	---------	---------

## AIRSEEDER HOSE- PVC MID RANGE

AGPASC025	25mm Clear/Black Suction (20m Roll)	25	
AGPASC032	32mm Clear/Black Suction (20m Roll)	32	
AGPASC038	38mm Clear/Black Suction (20m Roll)	38	
AGPASC045	45mm Clear/Black Suction (20m Roll)	45	
AGPASC050	51mm Clear/Black Suction (20m Roll)	51	
AGPASC063	63mm Clear/Black Suction (20m Roll)	63	
AGPASC075	76mm Clear/Black Suction (20m Roll)	76	



## AIRSEEDER HOSE- PVC HEAVY DUTY

AGPASG025	25mm Grey PVC Suction (20m Roll)	25	
AGPASG032	32mm Grey PVC Suction (20m Roll)	32	
AGPASG038	38mm Grey PVC Suction (20m Roll)	38	
AGPASG050	51mm Grey PVC Suction (20m Roll)	51	
AGPASG063	63mm Grey PVC Suction (20m Roll)	63	
AGPASG075	76mm Grey PVC Suction (20m Roll)	76	



## AIRSEEDER HOSE- RUBBER

AGPASR032	32mm Rubber Suction (20m roll)	32	44
AGPASR038	38mm Rubber Suction (20m roll)	38	50
AGPASR044	44mm Rubber Suction (20m roll)	45	57
AGPASR050	50mm Rubber Suction (20m roll)	51	61
AGPASR063	63mm Rubber Suction (20m roll)	63	75
AGPASR076	75mm Rubber Suction (20m roll)	76	90
AGPASR100	100 (4") Rubber Suction	102	118
AGPASR125	125mm (5") Rubber Suction	127	145
AGPASR150	150mm (6") Rubber Suction	152	174
AGPASR200	200mm (9") Rubber Suction		



## AUGER / 5:1 BIN HOSE

D1RFH100	Flexible Ducting TPR 4"	100	107
D1RFH125	Flexible Ducting TPR 5"	127	134
D1RFH150	Flexible Ducting TPR 6"	150	157
D1RFH175	Flexible Ducting TPR 7"	180	188
D1RFH200	Flexible Ducting TPR 8"	200	208
D1RFH225	Flexible Ducting TPR 9"	225	233
D1RFH250	Flexible Ducting TPR 10"	250	259

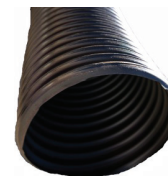

## CLEAR TUBING

P/ASB023-030	Blue Flex Superior Airseeder Tube (30m Roll)	23	30
P/ASB024-030	Blue Flex Superior Airseeder Tube (30m Roll)	25	31.5
P/ASB025-030	Blue Flex Superior Airseeder Tube (30m Roll)	25	32
P/ASB032-030	Blue Flex Superior Airseeder Tube (30m Roll)	32	38



PRICES EXCLUDE GST

T: (08) 9362 6811

35

F: (08) 9361 3263

# SPARE PARTS

## BOURGAULT

ITEM CODE	DESCRIPTION	PRICE	ITEM CODE	DESCRIPTION	PRICE
AB-3001	Double Shoot. Includes holder, point and backshoot.	\$286.00	AB-1026	CK Point suits Bourgault Paralink.	\$92.00

## CHAMBERLAIN

ITEM CODE	DESCRIPTION	PRICE	ITEM CODE	DESCRIPTION	PRICE
PCHCAP4	Cap Plow 4	P.O.A.	PCHCNS	Arm nut 1" 12 TPI	P.O.A.
PCHCAP5	Cap Plow 5	P.O.A.	PCHP563	Pin	P.O.A.
PCHCAST5	Spindle Casting No 5/6	P.O.A.	PCHSP4B	Spindle plow 4 B/L	P.O.A.
PCH889	Nut disc	P.O.A.	PCHSPL	Spindle plow 5/6	P.O.A.
PCHASS5	Spindle casting ASS 5/6	P.O.A.	CHAM43949	Fertiliser Star clockwise Suit Mark 2 & 3	\$34.50
PCHB559	Bush	P.O.A.	CHAM43947	Fertiliser Star anti clockwise Suit Mark 2 & 3	\$34.50
PCHCAP6	Cap plow 6	P.O.A.	CHAM58566	Feed Gate. Suit Mark 2 & 3	\$10.80
PCHCN2	CH 5/6 C/nut 1 1/4	P.O.A.	AC6010	Disc Plain 5mm 33mm SQ 24 inch	\$102.85
AC6015	Disc Plain 6mm 33mm SQ 24 inch	\$118.80	AC6020	Disc Plain 6mm 33mm SQ Scallop 24 inch	\$118.80
CHAM60296	Spindle [King Pin] 324mm long Suits Champion 236, 306, Countryman 306, [Countryman 354, C670 with fixed width front axle], 3380 fitted with original type 2 piece stub axle	\$146.40	CHAM70728	Female End 1" dia LH thread Tie Rod and Drag Link Ends. 2 x B670 +2 x B671 used. Suit Champion 236, MK111, C6100 Champion 306, Countryman 306 (Countryman 354, C670 with fixed front angle), 9G, Industrial MK11, B671 only used (Female) from Agric No.DM1504 and from Industrial No.IND1114	\$79.00
CHAM61071	Spindle [King Pin] 353mm long Suit 4080, 4080B, 4280 fitted with original type 2 piece stub axle	\$146.40	CHAM70727	Female End 1" dia RH thread Tie Rod and Drag Link Ends. 2 x B670 +2 x B671 used. Suit Champion 236, MK111, C6100 Champion 306, Countryman 306 (Countryman 354, C670 with fixed front angle), 9G, Industrial MK11, B671 only used (Female) from Agric No.DM1504 and from Industrial No.IND1114	\$79.00
CHAM60667	Bush. Suit Champion 236, 306, MK111 C6100, Countryman 306, 354, C670 3380, 4080, 4280, 4480, 4290, 4490, 4690	\$9.00			
CHAM37092	Thrust Bearing Suit Champion 236, 306, MK111, C6100, Countryman 306, 354, C670, 3380, 4080, 4280, 4480, 4290, 4490, 4690	\$18.60			

PRICES EXCLUDE GST

T: (08) 9362 6811



36

F: (08) 9361 3263

# SPARE PARTS

## CHAMBERLAIN continued

ITEM CODE	DESCRIPTION	PRICE
CHAM64481	Hub Front Axle Suit 3380, 4080, 4280, 4090, 4490, 4960	\$xx
		
CHAM69596	Seal. Suit Champion 236, 306, MK111 C6100, Countryman 306, 354, C670 3380, 4080, 4280, 4480, 4290, 4490, 4690	\$2.20
		
CHAM56858	Male End 1" dia LH thread Models with fixed axle width: 3380 4080, 4280, 4480, 4090, 4290, 4690 Models with Adjustable width axle: use B4671 on RH side only	\$90.00
		
CHAM56782	Male End 1" dia RH thread Models with fixed axle width: 3380 4080, 4280, 4480, 4090, 4290, 4690 Models with Adjustable width axle: use B4671 on RH side only	\$90.00
		





ITEM CODE	DESCRIPTION	PRICE
AL39316	Inner End Suit 4090 Four Wheel Drive	\$137.00
		
AL39318	RH Outer End Suit 4090 Four Wheel Drive	\$277.00
		
AL39315	LH Outer End Suit 4090 Four Wheel Drive	\$277.00
		



## EZEE-ON

ITEM CODE	DESCRIPTION	PRICE
AE1010	Disc 26 inch Plain. 8mm.	\$198.00
		

ITEM CODE	DESCRIPTION	PRICE
AE1011	Disc 26 inch Scallop. 8mm.	\$198.00

## FORWARD ENGINEERS

ITEM CODE	DESCRIPTION	PRICE
FE32501	Lift cylinder. Suits Forward Engineers FE 270. Supercedes CM17498	\$975.00
		
FE32502	Lift cylinder. Suits Forward Engineers FE 270. Supercedes CM16641	\$975.00
		
FE32503	Hydraulic lift cylinder. Suits Forward Engineers 270, 853, 846. Supercedes CM17499	\$975.00
		
FE32504	Hydraulic lift cylinder. Suits Forward Engineers 270, 853, 846. Supercedes CM17500	\$975.00
		

ITEM CODE	DESCRIPTION	PRICE
CM21134	Axle LH. Suits 636.	\$1,951.15
		
CM21135	Axle RH with pin. Suits 636.	\$1,951.15
		
FE30076	Axle drive with pin. Suits 660.	\$2,046.00
FE30012	Axle non drive. Suits 660.	\$2,046.00

PRICES EXCLUDE GST















T: (08) 9362 6811

37

F: (08) 9361 3263

# SPARE PARTS

## FORWARD ENGINEERS continued

ITEM CODE	DESCRIPTION	PRICE	ITEM CODE	DESCRIPTION	PRICE
CHAM73913	Engagement clutch. Suits Forward Engineers 846, 853, 620.	\$1,549.00	FE10189-F10	100mm axle. Suits 640, 680.	\$1,179.75
					
FE10500F20	Dog Clutch Plain. Suits Forward Engineers 640, 680, 6120 Rhino.	\$181.50	FE10175-F10	Axle. Suits 6120.	\$1,863.40
					
FE31650	Dog Clutch Emu. Suits Emu 10000.	\$312.20	CM21955 FE33007	Tyne assembly. Suits 853, 846, 270.	\$878.65
					
FE31652	Dog Clutch Emu. Suits Emu 10000.	\$341.25	CM21885	Shank only. Suits 853, 846, 270.	\$146.41
					
CHAM74759	Axle suit 5/8 pressed in studs. Suits 846, 853.	\$1,548.80	AN183318	Hub assembly. Suits 270.	\$435.75
					
CM21136	Axle tapped for 3/4 studs. Suits 846, 853.	\$1,436.90	CHAM64481	Hub. Cross Shaft Walkover Wheels. 4.6m thru 11.0m. Outrigger wheels 7.5 thru 16.5m. Suits 270.	\$600.16
					
CM21562	Spring. Only suit CHAM73913.	\$288.00	CHAM73962	Seed metering wheels. Suits 846, 853	\$11.25
					
CM20884	Engagement clutch. Suits Forward Engineers 636, 660.	\$1,191.85	CHAM73963	Distributor gate. Suits 846, 853.	\$7.76
					
CM21766	Spring. Only suit CM20884.	\$237.16	CHAM73964	Fertiliser wheels. Suits 846, 853.	\$13.85
					
CM16977	Solenoid suits 636, 620, 630, 660	\$402.35	CM19961	Support conveyor assembly stainless. Suits 520, 620, 630.	\$2,158.65
					
FE10486F20	Dog Clutch Sprocket. Suits Forward Engineers 640, 680, 6120 Rhino.	\$302.50			
					

## GRIZZLY

ITEM CODE	DESCRIPTION	PRICE	ITEM CODE	DESCRIPTION	PRICE
AG1010	Disc 28 inch scallop 8mm	\$215.00	AG1011	Disc 28 inch fluted 8mm	\$215.00
					

PRICES EXCLUDE GST

T: (08) 9362 6811



38

F: (08) 9361 3263



# SPARE PARTS

## JET STREAM 5:1

ITEM CODE	DESCRIPTION	PRICE	ITEM CODE	DESCRIPTION	PRICE
53292L	Chain 59 Paddle (Extended)	\$324.50	22155/06l	Sprocket 1/2" x 60 Tooth	\$82.30
					
53292S	Chain 49 Paddle (Standard)	\$324.50	22220/06l	Sprocket 5/8" x 15 Tooth	\$41.15
					
53260	Chain 15 Paddle Side Discharge	\$137.50	22226/06l	Sprocket 5/8" x 26 Tooth	\$50.85
					
53286	Shaft Top 292L 3/4"	\$12.50	22349/04l	Sprocket 5/8" x 30 Tooth	\$82.30
					
53285	Shaft Bottom 356L 3/4"	\$12.50	22521	Sprocket Top 10T Alternate 3/4" Bore	\$78.65
					
10567	Bearing kit 3/4" (1 x EN204-12, 2 x 47MST, 2 x 8 x 20).	\$33.00	22516	Sprocket Top 9T Alternate 3/4" Bore	\$78.65
					
21070	Tension Spring	\$29.65	22510/06l	Sprocket 7 Tooth Alternate	\$118.00
					
53287	Headslide Yoke	\$54.45	22515	Sprocket 9 Tooth Alternate Long Boss c/w Bush	\$206.55
					
53287/2	Yoke Lever	\$22.40	22120/06l	Sprocket 1/2" x 15 Tooth	\$48.40
					
01009N2	Eyebolt	\$17.55	22353F	Front Dog Clutch	\$199.65
					
19543	190mm Pulley to suit Side Elevator	\$83.50	22353R	Rear Dog Clutch	\$199.65
					
24001/1	Sliding Tube 6"	\$159.75	22354F	Front Sprocket Dog Clutch	\$223.85
					
24001/6	Square to Round	\$90.75	22354R	Rear Sprocket Dog Clutch	\$223.85
					
D1RFH150	Flexible Ducting 6" 1/2 metre	\$61.25			
					

PRICES EXCLUDE GST

T: (08) 9362 6811

39

F: (08) 9361 3263

# SPARE PARTS

## JOHN DEERE / CONSERVA PAK

ITEM CODE	DESCRIPTION	PRICE	ITEM CODE	DESCRIPTION	PRICE
AJ1006	Conserva Point. Suits Conserva Pak.	\$78.00	AJ1051	15 inches aluminium rim/ tyre 100mm complete suits 1870	\$205.00
AJ1285	Seed Boot. Full tungsten tile protection.	\$85.00	CM21136	Axle tapped for 3/4 studs. Suits 746, 753.	\$1,436.90
AJ1286	Fertiliser Shoot.	\$65.00	CM21134	Axle LH. Suits 667.	\$1,951.15
AJ1218	Presswheel Scraper.	\$20.00	CM21135	Axle RH with pin. Suits 667.	\$1,951.15
AJ1219	Bushings suit fertiliser shank.	\$26.00	AJ1040	Solid flat tyre width 80mm OD 21 inches, suits 1820, 1830.	\$181.50
AFE32501	Lift cylinder. Suits John Deere 275 Supercedes CM17498	\$975.00	AJ1041	Solid flat tyre width 100mm OD 21 inches, suits 1820, 1830.	\$181.50
FE32502	Lift cylinder. Suits John Deere 275 Supercedes CM16641	\$975.00	AJ1050	15 inches aluminium rim/ tyre 80mm complete suits 1870	\$189.60
FE32503	Hydraulic lift cylinder. Suits John Deere 275, 753, 746. Supercedes CM17499	\$975.00	CM21955 FE33007	Tyre assembly. Suits 753, 746, 275.	\$878.65
FE32504	Hydraulic lift cylinder. Suits John Deere 275, 753, 746. Supercedes CM17500	\$975.00	CM21885	Shank only. Suits 753, 746, 275.	\$146.41
CHAM73913	Engagement clutch. Suits John Deere 746, 753.	\$1,549.00	AN183318	Suits 275.	\$453.75
CM21562	Spring only. Suit CHAM73913.	\$288.00	CHAM64481	Hub. Cross Shaft Walkover Wheels. 4.6m thru 11.0m. Outrigger wheels 7.5 thru 16.5m. Suits 270.	\$600.16
CM20884	Engagement clutch. Suits John Deere 667.	\$1,191.85	CHAM73962	Seed metering wheels. Suits 746, 753.	\$11.25
CM21766	Spring only. Suit CM20884.	\$237.16	CHAM73963	Distributor gate. Suits 746, 753.	\$7.76
CM16977	Solenoid suit 667, 647.	\$402.35	CHAM73964	Fertiliser wheels. Suits 746, 753.	\$13.85
CHAM74759	Axle suit 5/8 pressed in studs. Suits 746, 753.	\$1,548.80	CM19961	Support conveyor assembly stainless. Suits 547, 647.	\$2,158.65

PRICES EXCLUDE GST

T: (08) 9362 6811

40

F: (08) 9361 3263

# SPARE PARTS

## MORRIS

ITEM CODE	DESCRIPTION	PRICE	ITEM CODE	DESCRIPTION	PRICE
AM2001	Paired Row or choice of Maxi Backshoots. Point included.	\$310.00	AM1010	Electric Clutch 200lb (OEM Part No N33403) Suits 8000 Series.	\$645.00
AM1030	CT Point suits Morris Contour 2.	\$68.00			

## SIMPLICITY

ITEM CODE	DESCRIPTION	PRICE	ITEM CODE	DESCRIPTION	PRICE
AS1001	Electro Magnetic Clutch. Suits most models.	\$545.00	AS1010	Gearbox 1:1 Ratio.	\$342.55
AS1005	Zero Max.	P.O.A.	AS1015	Gearbox 3.3:1 Ratio.	\$378.40

PRICES EXCLUDE GST

T: (08) 9362 6811

41

F: (08) 9361 3263

# LIQUID EQUIPMENT

WETTERS	PRECISION WETTER	WetnGo	iWETTER
20 litre drum	PW20	WG20	IW20
110 litre drum	PW110	WG110	IW110
200 litre drum	PW200	WG200	IW200
1000 litre shuttle	PW1000	WG1000	IW1000



## PREMIUM SOIL CONDITIONING AGENT

**PRECISION WETTER IS AN AUSTRALIAN MADE AND UNIQUELY FORMULATED BLEND OF NEW GENERATION NON-IONIC, SURFACE-ACTIVE AGENTS DESIGNED TO ELIMINATE PROBLEMS CAUSED BY WATER REPELLANT SOILS.**

**Precision Wetter** is ideal for Non Wetting Soils

- Promotes deeper root growth
- Improves soil nutrient use
- Utilizes available moisture
- Economical and easy to use
- Eliminates 'Dry Patch'
- Reduces erosion
- Improves germination



**Precision Wetter** provides superior wetting to a variety of hydrophobic soil types including soils with low organic matter and it is balanced to provide the right amount of wetting span. Broadacre crops can benefit immensely by the application of a soil wetter into the soil close to the seed. This provides the environment for an even germination and sustained crop growth by ensuring that any soil moisture is readily available to the crop.

**Precision Wetter** provides superior wetting to a variety of hydrophobic soil types including soils with low organic matter and it is balanced to provide the right amount of wetting span. Broadacre crops can benefit immensely by the application of a soil wetter into the soil close to the seed. This provides the environment for an even germination and sustained crop growth by ensuring that any soil moisture is readily available to the crop.



SITUATION	APPLICATION RATE		COMMENTS
Broadacre Band Spray for Furrow Seeding	Press wheels at 25cm spacing	0.6 to 2L/ha	Maintain spray pressure at a rate high enough to produce a strong jet. Water rate: 50 to 100L/ha. Use higher rates for extremely high water repellent soils.
	Press wheels at 15cm spacing	1 to 4L/ha	
	Boom Spray	4 to 8L/ha	Ideally spray immediately before rain is due.
Seeding establishment	Band spray: 1 to 3L/ha Boom spray: 5 to 10L/ha		Water rate: 75 to 100L/ha
Landscaping with foliage	5 to 10L/ha		Preferable to water immediately after application to ensure soil contact.
Turf Management	Boom spray: 2.5 to 5L/ha		Water rate: 400 to 800L/ha Water every 15 to 30 days. Water well after application to ensure soil contact.

PRICES EXCLUDE GST

**T: (08) 9362 6811**

**42**

**F: (08) 9361 3263**

# LQS20

The LQS20 is a small low flow liquid auto-rate pump and control module. It is ideal for small implements and low rate applications where little agitation is required. It can also be configured for direct chemical injection into the output of another module (Order Code LQS20-SPK). In standard configuration it can control from 1 to 20 L/min (5.3 Ga/min). 0.5 – 10L/min option available.

<b>FUNCTION</b>	Low Volume Single liquid dosing
<b>MAX OUTPUT</b>	20LPM 5.3GPM(US) 4.4GPM (Imperial)
<b>DIMENSIONS</b>	W 510mm X D 870mm X H 590mm
<b>WEIGHT</b>	63kg (Module only)
<b>PUMP</b>	Hydraulically driven piston diaphragm pump
<b>HYDRAULICS</b>	21LPM 5.5GPM (US) 4.6GPM (Imperial)
<b>ELECTRICAL</b>	12 DC: Single Swath   2A Section Control (8 sections)   6A



- |                 |   |
|-----------------|---|
| <b>FEATURES</b> | <ul style="list-style-type: none"> <li>• Precision rate control valve set incorporating fast shutoff regulating valve and flowmeter</li> <li>• Module mounted pressure gauge</li> <li>• Pressure transducer &amp; pump speed sensor for on-screen monitoring</li> <li>• Suction filter</li> <li>• Front panel controls for fertiliser/clean water tank selection &amp; function selection (operate, purge, dump)</li> <li>• Prescription map variable rate control when integrated with Precision Ag Controllers</li> <li>• Section control compatible</li> <li>• Robust, chemical resistant components</li> <li>• Tank plumbing kit included</li> <li>• Compact module design</li> </ul> |
|-----------------|---|

# LQS70

LQS70 is a single liquid auto-rate pump and control module. It provides enough capacity for applying liquids at rates with good tank agitation for up to 4000L tank capacity.

<b>FUNCTION</b>	Single liquid rate control
<b>MAX OUTPUT</b>	76 LPM 20GPM(US) 16.7GPM (Imperial)
<b>DIMENSIONS</b>	W 710mm x D 750mm x H 570mm
<b>WEIGHT</b>	85kg (Module only)
<b>PUMP</b>	Hydraulically driven piston diaphragm pump
<b>HYDRAULICS</b>	27.5LPM 7.3GPM (US) 6.0GPM (Imperial)
<b>ELECTRICAL</b>	12 DC: Single Swath   2A Section Control (8 sections)   6A
<b>DUAL MODULE</b>	LQS70 module can be run in series with all modules.



- |                               |  |
|-------------------------------|--|
| <b>LIQUID SECTION CONTROL</b> | Compatible   |
| <b>FEATURES</b>               | <ul style="list-style-type: none"> <li>• Precision rate control valve set incorporating fast shutoff regulating valve and flowmeter</li> <li>• Module mounted pressure gauge</li> <li>• Pressure transducer &amp; pump speed sensor for on-screen monitoring</li> <li>• Suction filter</li> <li>• Front panel controls for fertiliser/clean water tank selection &amp; function selection (operate, purge, dump)</li> <li>• Prescription map variable rate control when integrated with many Precision Ag control systems</li> <li>• Section control compatible</li> <li>• Robust, chemical resistant components</li> <li>• Tank plumbing kit included</li> <li>• Compact module design</li> </ul> |

PRICES EXCLUDE GST

**T: (08) 9362 6811**

**43**

**F: (08) 9361 3263**

# LQS120

The new compact LQS120 is a single liquid auto-rate pump and control module. It provides capacity for applying liquids at higher rates with good tank agitation for up to 5000L tank capacity.

<b>FUNCTION</b>	High Volume Single liquid rate control
<b>MAX OUTPUT</b>	126LPM 33GPM(US) 27.7GPM (Imperial)
<b>DIMENSIONS</b>	W 800mm x D 860mm x H 633mm
<b>WEIGHT</b>	109kg (Module only)
<b>PUMP</b>	Hydraulically driven piston diaphragm pumps
<b>HYDRAULICS</b>	27.5LPM 7.3GPM (US) 6.0GPM (Imperial)
<b>ELECTRICAL</b>	12 DC: Single Swath   2A Section Control (8 sections)   6A



## FEATURES

- Precision rate control valve set incorporating fast shutoff regulating valve and flowmeter
- Module mounted pressure gauge
- Pressure transducer & pump speed sensor for on-screen monitoring
- Suction filter
- Front panel controls for fertiliser/clean water tank selection & function selection (operate, purge, dump)
- Prescription map variable rate control when integrated with many Precision Ag control systems
- Section control compatible
- Robust, chemical resistant components
- Tank plumbing kit included
- Compact module design

# LQS180

The new compact LQS180 is a single liquid auto-rate pump and control module. It provides capacity for applying liquids at higher rates with good tank agitation for larger tanks (5000L and over).

<b>FUNCTION</b>	High Volume Single liquid rate control
<b>MAX OUTPUT</b>	170 LPM 45GPM (US) 37.5GPM (Imperial)
<b>DIMENSIONS</b>	W 800mm X D 860mm X H 718mm
<b>WEIGHT</b>	121kg (Module only)
<b>PUMP</b>	Hydraulically driven piston diaphragm pumps
<b>HYDRAULICS</b>	27.5LPM 7.3GPM (US) 6.0GPM (Imperial)
<b>ELECTRICAL</b>	12 DC: Single Swath   2A Section Control (8 sections)   6A



## FEATURES

- Precision rate control valve set incorporating fast shutoff regulating valve and flowmeter
- Module mounted pressure gauge
- Pressure transducer & pump speed sensor for on-screen monitoring
- Suction filter
- Front panel controls for fertiliser/clean water tank selection & function selection (operate, purge, dump)
- Prescription map variable rate control when integrated with many Precision Ag control systems
- Section control compatible
- Robust, chemical resistant components
- Tank plumbing kit included
- Compact module design

PRICES EXCLUDE GST

**T: (08) 9362 6811**

**44**

**F: (08) 9361 3263**

# SINGLE AND DUAL STACKER KITS

## STANDARD

Our standard manifold configurations provide even distribution of liquid across tillage bars with up to 100 rows. Configurations are available with from one to six manifold assemblies, in single or dual liquid configurations. Each manifold is capable of delivering liquid to up to 20 rows. To avoid damage to delivery tubing, at least one manifold per folding section is required. i.e. a double fold tillage bar requires 5 manifolds.

### SINGLE

ORDER CODE	CONFIGURATION DESCRIPTION
LQS-ASST1	M1 Single Stacker (max. 20 outlets)
LQS-ASST2	M2 Single Stacker (max. 40 outlets)
LQS-ASST3	M3 Single Stacker (max. 60 outlets)
LQS-ASST4	M4 Single Stacker (max. 80 outlets)
LQS-ASST5	M5 Single Stacker (max. 100 outlets)
LQS-ASST6	M6 Single Stacker (max. 120 outlets)

Example. M3 Single Stacker



### DUAL

ORDER CODE	CONFIGURATION DESCRIPTION
LQS-ASSD1	M1 Dual Stacker (max. 40 outlets) (max 20 outlets per channel)
LQS-ASSD2	M2 Dual Stacker (max. 80 outlets) (max 40 outlets per channel)
LQS-ASSD3	M3 Dual Stacker (max. 120 outlets) (max 60 outlets per channel)
LQS-ASSD4	M4 Dual Stacker (max. 160 outlets) (max 80 outlets per channel)
LQS-ASSD5	M5 Dual Stacker (max. 200 outlets) (max 100 outlets per channel)
LQS-ASSD6	M6 Dual Stacker (max. 240 outlets) (max 120 outlets per channel)

Example. M3 Dual Stacker

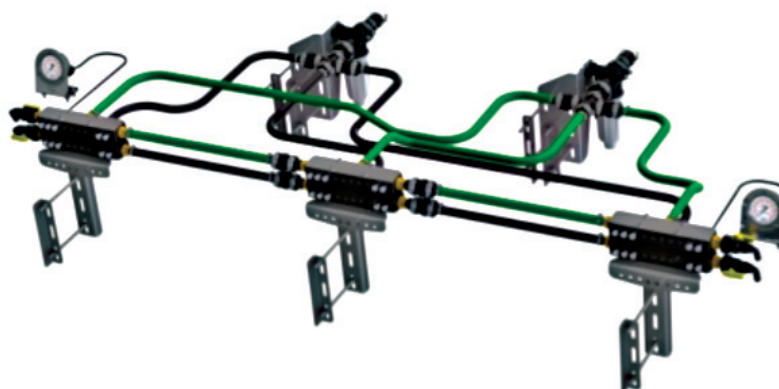

PRICES EXCLUDE GST

T: (08) 9362 6811

45

F: (08) 9361 3263

# SECTION CONTROL STACKER KITS

## SECTION CONTROL

Section Control manifold configurations include a Section Control module. This module incorporates 3-way electric ball valves in a constant flow configuration for instantaneous shut-off with seamless rate control. The modules come with a stainless steel mounting bracket, pressure gauge and line filter.

### SINGLE

ORDER CODE	CONFIGURATION DESCRIPTION
LQS-ACST2	M2 Section Control Single Stacker (max. 40 outlets)
LQS-ACST3	M3 Section Control Single Stacker (max. 60 outlets)
LQS-ACST4	M4 Section Control Single Stacker (max. 80 outlets)
LQS-ACST5	M5 Section Control Single Stacker (max. 100 outlets)
LQS-ACST6	M6 Section Control Single Stacker (max. 120 outlets)
LQS-ACST8	M8 Section Control Single Stacker (max. 160 outlets)
LQS-ACST9	M9 Section Control Single Stacker (max. 180 outlets)

Example. M3 Section Control Single Stacker



### DUAL

ORDER CODE	CONFIGURATION DESCRIPTION
LQS-ACSD2	M2 Section Control Dual Stacker (max. 40 outlets per channel)
LQS-ACSD3	M3 Section Control Dual Stacker (max. 60 outlets per channel)
LQS-ACSD4	M4 Section Control Dual Stacker (max. 80 outlets per channel)
LQS-ACSD5	M5 Section Control Dual Stacker (max. 100 outlets per channel)
LQS-ACSD6	M6 Section Control Dual Stacker (max. 120 outlets per channel)
LQS-ACSD8	M8 Section Control Dual Stacker (max. 160 outlets per channel)
LQS-ACSD9	M9 Section Control Dual Stacker (max. 180 outlets per channel)

Example. M3 Section Control Dual Stacker

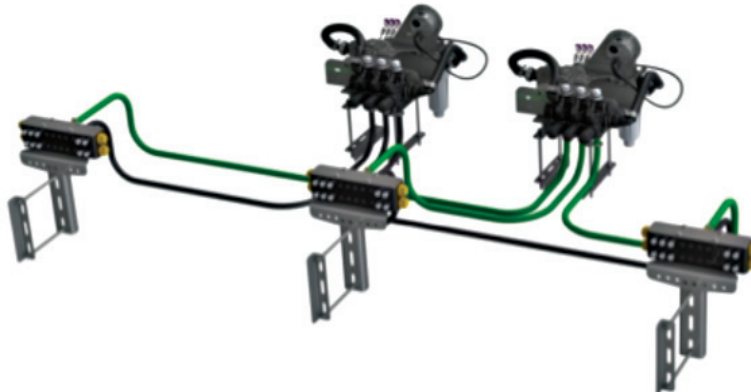







PRICES EXCLUDE GST



# AIRTOOL MANIFOLD CONFIGURATIONS

Liquid Systems has a range of terminal configurations for liquid distribution setups on air seeder tillage bars. With Air Tool Terminal Configurations, the line from each manifold outlet can be split into two separate delivery lines. All terminal configurations include in-line check valves for quick shut-off and start-up. All connections are push-fit for simple assembly and maintenance.

<p>Example: Standard Terminals connected to Stacker Manifold.</p>	<p><b>LOW RATE 4MM (A)</b> Order Code: LQS-ATL4</p>	<p><b>STANDARD</b> Order Code: LQS-ATST</p>
	 <ul style="list-style-type: none"> <li>• 8mm tees to split flow from manifold</li> <li>• 8mm delivery line</li> <li>• inline check valve</li> <li>• line meters included (choose 3 sizes)</li> <li>• 8-4mm Stem Reducer</li> <li>• V3 rubber union</li> <li>• 4mm OD x 1.8mm ID terminal tube</li> </ul> <p>Fits to 6.35mm (1/4") OD x 4.53mm ID stainless steel delivery tube (not included)</p> <p>Suitable for rates up to 100L/Ha, 10 US Gal/ Acre on 9-12" Spacing</p>	 <ul style="list-style-type: none"> <li>• 8mm tees to split flow from manifold</li> <li>• 8mm delivery line</li> <li>• inline check valve</li> <li>• line meters included (choose 3 sizes)</li> <li>• V4 rubber union</li> <li>• 5mm OD x 2.5mm ID terminal tube</li> </ul> <p>Fits to 9.53mm (3/8") OD x 6.27mm ID stainless steel delivery tube (not included)</p> <p>Good stream control across a wide range of application rates. For openers spaced 9"-15"</p>
<p><b>HIGH RATE</b> Order Code: LQS-ATHR</p>	<p><b>LOW VOLUME FIBP</b> Order Code: LQS-ATFB</p>	<p><b>DBS LOW VOLUME FIBP</b> Order Code: LQS-AT3F</p>
 <ul style="list-style-type: none"> <li>• 8mm tees to split flow from manifold</li> <li>• 8mm delivery line</li> <li>• inline check valve</li> <li>• line meters included (choose 3 sizes)</li> <li>• 8mm OD terminal tube</li> </ul> <p>Fits to 6.35mm (1/4") OD x 4.53mm ID stainless steel delivery tube (not included)</p> <p>Suitable for high rate applications or points with 1/4" liquid delivery tubes</p>	 <ul style="list-style-type: none"> <li>• 8mm tees to split flow from manifold</li> <li>• 8mm delivery line</li> <li>• inline check valve</li> <li>• 8-5mm stem reducer</li> <li>• V4 rubber union</li> <li>• 5mm OD x 1.2mm ID yellow terminal tube</li> </ul> <p>Fits to 9.53mm (3/8") OD x 6.27mm ID stainless steel delivery tube (not included)</p> <p>Permits large bore/ ultra-low application. Ability to apply difficult materials. No Line meter is used with this option as back pressure is created via line friction - the longer the line the higher the back pressure</p>	 <ul style="list-style-type: none"> <li>• 8mm tees to split flow from manifold</li> <li>• 8mm delivery line</li> <li>• inline check valve</li> <li>• 8-4mm stem reducer</li> <li>• 4mm OD x 1.8mm ID purple terminal tube (30mm length)</li> <li>• 4-3mm stem reducer                             <ul style="list-style-type: none"> <li>• 12 x 3 Cable Gland</li> <li>• 1/4" V3 rubber union</li> <li>• 3mm OD x 1.2mm ID orange terminal tube</li> </ul> </li> </ul> <p>Fits inside 6.35mm (1/4") OD DBS Stainless drop tube</p> <p>Permits large bore/ ultra-low application. Ability to apply difficult materials. No Line meter is used with this option as back pressure is created via line friction - the longer the line the higher the back pressure</p>

PRICES EXCLUDE GST







T: (08) 9362 6811

47







F: (08) 9361 3263

# LIQUID SYSTEMS SPARES



## 1 1/2" SUCTION FILTER ASSEMBLIES - MODULES - 176, Ai70 & Spiker

ITEM CODE	DESCRIPTION	UNIT	PRICE
3142462	1 1/2" 32 mesh Suction Filter	EACH	\$145.20
			
314000.050	O'-Ring for 1 1/2" Suction Filter Bowl	EACH	\$6.85
			
G10061	1 1/2" - Hose Tail 90 Degree	EACH	\$6.95
			
G10061	O'-Ring for 1 1/2" Fly Nut	EACH	\$1.87
			
2002060	1 1/2" Fly Nut	EACH	\$4.62
			
3142002.030	Suction Filter Screen 1-1/2" 32 Mesh	EACH	\$49.17
			
AG-314300.060	O-ring for 1-1/2" Suction Filter Screen	EACH	\$4.65
			







## 2" SUCTION FILTER ASSEMBLIES - MODULES - 276, Ai120 & G22

ITEM CODE	DESCRIPTION	UNIT	PRICE
3162472	SHORT 2" 32 mesh 316 Series Suction Filter	EACH	\$193.60
			
316000.050	O'-Ring for 2" Suction Filter Bowl	EACH	\$11.11
			
3162002.030	SHORT 2" 32 mesh Suction Filter Screen	EACH	\$63.80
			
3172472	2" 32 mesh 317 Series Suction Filter	EACH	\$216.80
			
AG-316400.060	Yellow Filter Plug and Valve (for both 3172472 & 3162472 Filters)	EACH	\$30.69
			
3172002.030	2" 32 mesh Suction Filter Screen	EACH	\$77.00
			
116740	2" Hose Tail 90°	EACH	\$10.00
			



## 2" SUCTION FILTER ASSEMBLIES - MODULES - 276, Ai120 & G22 continued

ITEM CODE	DESCRIPTION	UNIT	PRICE
2002070	2" Fly Nut	EACH	\$6.40
			
G100071	O' Ring for 2" Fly Nut	EACH	\$1.90
			

## 1 1/4" SELECTOR VALVE ASSEMBLIES: SOURCE Selector Valve - MODULES 176, Ai70, 276 & Spiker FUNCTION Selector Valve - MODULES 176, Ai70, 276, Ai120, G22 & Spiker

ITEM CODE	DESCRIPTION	UNIT	PRICE
45531115	1 1/4" 3 Way Ball Valve (Continuous Flow)	EACH	\$213.40
			
454235H.020	1 1/4" 3 Way Ball Only (Continuous Flow)	EACH	\$317.90
			
4542235.070	Teflon Seal for 1 1/4" 3 way ball valve	EACH	\$320.10
			
45531115	1 1/4" 3 Way Ball Valve (Continuous Flow)	EACH	\$111.10
			
454235H.020	1 1/4" 3 Way Ball Only (Continuous Flow)	EACH	\$38.05
			
4542235.070	Teflon Seal for 1 1/4" 3 way ball valve	EACH	\$17.93
			

## 1 1/2" SELECTOR VALVE ASSEMBLIES: SOURCE Selector Valve - MODULES Ai20, & G22

ITEM CODE	DESCRIPTION	UNIT	PRICE
LL03092	Source Selector Valve 1.5" 450 (No Clamps) for Ai120 Modules	EACH	\$253.00
			
LL03094	Source Selector Valve 1.5" 300 (No Clamps) for G22 Modules	EACH	\$253.00
			
AG-45531116	1 1/2" 3 way Ball Valve (Continuous flow)	EACH	\$129.80
			

## 2" SELECTOR VALVE ASSEMBLY: 180 UPGRADE FOR MODULES Ai20, & G22

ITEM CODE	DESCRIPTION	UNIT	PRICE
LL03093	Source Selector Valve 2" 450 (No Clamps) for Ai120 180 Upgrade	EACH	\$313.50
			

PRICES EXCLUDE GST

T: (08) 9362 6811

48

F: (08) 9361 3263

# LIQUID SYSTEMS SPARES

## 2" SELECTOR VALVE ASSEMBLY: 180 UPGRADE FOR MODULES Ai20, & G22

ITEM CODE	DESCRIPTION	UNIT	PRICE
LL03095	Source Selector Valve 2" 300 (No Clamps) for Ai120 180 Upgrade	EACH	\$312.40
AG-45531117	2" 3 way Ball Valve (Continuous flow)	EACH	\$165.00

## 2073 PUMP - MODULES 176, PR-1, Ai70 & 276

689021	Series Hydraulic Sandwich Control Block	EACH	\$811.80
B79428	Isolating switch for Series Hydraulic Sandwich	EACH	\$179.30
LL03127	2073/2136 Pump Bell Housing (secondary pump requires plug)	EACH	\$386.10
L03040	2073/2136/2180 Pump Sleeve	EACH	\$224.40
MR50CU	50CC Hydraulic motor	EACH	\$850.30
689904-20	Flow Control 20 LPM	EACH	\$1,059.30
95.0040.36.2	HPS Diaphragms for 2073 Pumps	EACH	\$63.80
63.9872.97.3	Valve Kit for 2073 Pumps 6 x 28.9809.97.3 (SS Valves) 6 x 80.3320.60.2 (Orings 5 x 40) 4 x 80.3219.80.2 (Orings 3,0 x 39)	KIT	\$734.80
80.2143.10.2	Viton Oil Seal (Dia. 35mm x 52mm x 7mm)	EACH	\$69.30
2073 EH Pump	Enhanced Bertolini 2073 Pump	EACH	\$1,639.00

## 2136 PUMP for MODULES - Ai120 & G22

ITEM CODE	DESCRIPTION	UNIT	PRICE
BL-689021	Series Hydraulic Sandwich Control Block (Dual G22/180UPG)	EACH	\$811.80

## 2136 PUMP for MODULES - Ai120 & G22 continued

ITEM CODE	DESCRIPTION	UNIT	PRICE
BL-B79428	Isolating switch for Series Hydraulic Sandwich (Dual G22/180UPG)	EACH	\$179.30
LL03127	2073/2136 Pump Bell Housing (secondary pump requires plug)	EACH	\$386.10
L03040	2073/2136/2180 Pump Sleeve	EACH	\$224.40
MR50CU	50CC Hydraulic motor	EACH	\$850.30
689904-20	Flow Control 20 LPM	EACH	\$1,059.30
703028	PWB2V Air Pressure Tank 2L 1" BSP	EACH	\$123.20
62.0040.36.2	HPS Diaphragm for 2136 Pumps	EACH	\$96.80
62.0040.00.2	Desmopan Diaphragm for 2136 Pumps	EACH	\$61.60
62.9805.97.3	Valve Kit for 2136 Pumps 6 x 28.9809.97.3 (SS Valves), 6 x 80.3314.00.2 (Orings 4,5 x 40)	KIT	\$726.00
80.2143.10.2	Viton Oil Seal (Dia. 35mm x 52mm x 7mm)	EACH	\$69.30
2136 EH Pump	Enhanced Bertolini 2136 Pump	EACH	\$2,332.00

## 2180 PUMP

689021 Block	Series Hydraulic Sandwich Control	EACH	\$811.80
B79428	Isolating switch for Series Hydraulic Sandwich	EACH	\$179.30
MR50CU	50CC Hydraulic motor	EACH	\$850.30

PRICES EXCLUDE GST







T: (08) 9362 6811

49



F: (08) 9361 3263

# LIQUID SYSTEMS SPARES

## 2180 PUMP continued

ITEM CODE	DESCRIPTION	UNIT	PRICE
689904-20	Flow Control 20 LPM	EACH	\$1,059.30
			
62.0040.36.2	HPS Diaphragm for 2180 Pumps (4 x Diaphragms required for 2180 pump)	EACH	\$96.80
			
62.0040.00.2	Desmopan Diaphragm for 2180 Pumps	EACH	\$61.60
			
28.9884.97.3	Valve Kit for 2180 Pump. 8 x 28.9809. 97.3 (SS Valves) 8 x 80. 3314.00.2 (Orings 4,5 x 40) 4 x 80.3209.40.2 (Orings 2,62 x 44,12)	KIT	\$1,008.70
			
80.2143.10.2	Viton Oil Seal (Dia. 35mm x 52mm x 7mm)	EACH	\$69.30
			
2180 EH Pump	Enhanced Bertolini 2180 Pump	EACH	\$3,388.00
			









## PRESSURE RELIEF VALVE - All Modules Except Spiker

MPRV100-100	100 PSI Pressure Relief Valve	EACH	\$150.70
			
FC100	1" Flange Clamp	EACH	\$18.50
			
M100G	1"EPDM Gasket (‘O’ ring)	EACH	\$3.85
			



## TANK AGITATION

5022043	Small Tank Agitator with 3mm Nozzle	EACH	\$32.90
			
5022045	Small Tank Agitator with 5mm Nozzle	EACH	\$32.90
			
502163	Large Tank Agitator with 3mm Nozzle	EACH	\$92.40
			
502165	Large Tank Agitator with 5mm Nozzle	EACH	\$92.40
			

## RATE CONTROL MODULE VALVE SETS

ITEM CODE	DESCRIPTION	UNIT	PRICE
57-10100	TeeJet 801 Flowmeter	EACH	\$955.90
			
16-00024	Sensor Insert, 801 Flowmeter	EACH	\$337.70
			
461BEC-2F-C	460 Manifold Shut Off Valve	EACH	\$726.00
			
LS-2 way DT	Deustch DT 2 wire connector for regulating valve	EACH	\$9.79
			
LS-Metri-Pack	3 wire Metri-Pack connector for shutoff valve or section valve	EACH	\$9.90
			
56610-18- 460BR	Liquid Systems Custom TeeJet 460 Regulating Valve	EACH	\$831.60
			
LL03087	0-10 bar Pressure Transducer with lead & connector	EACH	\$370.70
			
TL2	Pressure Transducer with lead & connector	EACH	\$692.60
			

## SECTION CONTROL

431EC-3-D	TeeJet 430 3 way manifold section valve	EACH	\$530.20
			
58480EC-05	0.5m 3 wire mini-din cable for section valve	EACH	\$27.80
			
LS-Metri-Pack	3 wire Metri-Pack connector for shutoff valve or section valve	EACH	\$11.60
			

## MODULE PRESSURE GAUGE KITS

LL03003	Module Dual Scale 10 Bar Back Mount Pressure Gauge Assembly (Kit includes fixings)	KIT	\$517.00
			

PRICES EXCLUDE GST

T: (08) 9362 6811

50

F: (08) 9361 3263

# LIQUID SYSTEMS SPARES

## MODULE PRESSURE GAUGE KITS *continued*

ITEM CODE	DESCRIPTION	UNIT	PRICE
505.888.345804	PR-1 Gauge 0/10 Dual Scale 1/2" NPT Direct Bottom mount	EACH	\$389.40
			
<b>SPIKER</b>			
BL689065H	Series Hydraulic Sandwich Control Block [SPK]	EACH	\$1,342.00
			
BL-B79428	Isolating switch for Series Hydraulic Sandwich (SPK)	EACH	\$179.30
			
8630001	Spiker Shut-off Valve	EACH	\$546.70
			
4621AA00000	Orion Flowmeter 0.5-10 LPM	EACH	\$2,640.00
			
8630026S	Spiker Regulating Valve	EACH	\$639.10
			
465521	Pressure Relief Valve	EACH	\$280.50
			
505.7731079.10	Spiker Pressure Gauge Sgle Scale 0/1600KPA BottMount	EACH	\$276.10
			
MM32C	31.8cc Hydraulic Motor inc mounting flange	EACH	\$619.30
			
94.9871.97.3	2025 Diaphragm Kit for 2025 Pumps 2 x 94. 0040.31.2 (Buna Diaphragms), 1 x 94.0041.31.2 (Damper Daiphram) 4 x O rings	EACH	\$140.80
			
94.9888.97.3	Valve Kit for 2025 Pumps 4 x 94.9828. 97.3 (SS Valve Assy) 4 x 82.4154.50.20 (Gasket)	KIT	\$147.40
			
VENT 20	Venturi 20MM Injector	EACH	\$353.10
			
94.8609.97	Bertolini 2025 Poly PM- VF 2020 outlet	EACH	\$1,148.40
			

## STACKER DISTRIBUTION SYSTEMS

ITEM CODE	DESCRIPTION	UNIT	PRICE
PPM0208W	Equal Tee 8mm	EACH	\$6.16
			
PPM0408W	Equal joiner 8mm	EACH	\$4.07
			
PPM0808W	Plug 8mm	EACH	\$1.10
			
PM060804E	Stem Reducer OD 8mm-OD 4.0mm	EACH	\$3.65
			
PM060805E	Stem Reducer OD 8mm-OD 5.0mm	EACH	\$3.85
			
PM060806E	Stem Reducer OD 8mm-OD 6.0mm	EACH	\$3.75
			
PM061008E	Stem Reducer OD 10mm-OD 8.0mm	EACH	\$4.40
			
5-16SCV	5/16" Single Check Valve	EACH	\$32.90
			
KQ2H23-04A	Push in Reducer 4mm-3.2mm	EACH	\$5.17
			
TRFMG12	M12mm x 3mm Nylon Cable Gland	EACH	\$2.10
			
PM2308E	8mm Two Way Divider	EACH	\$7.81
			
PM2310E	10mm Two Way Divider	EACH	\$8.40
			
M100075BRB	1" Flange x 3/4" Hose Barb	EACH	\$3.41
			
PM1210E	10mm Bulkhead Connector	EACH	\$11.00
			

PRICES EXCLUDE GST















T: (08) 9362 6811

51

F: (08) 9361 3263

# LIQUID SYSTEMS SPARES

## STACKER DISTRIBUTION SYSTEMS continued

ITEM CODE	DESCRIPTION	UNIT	PRICE
M100075FPT	1" Flange x 3/4" Female Thread	EACH	\$3.85
			
MCV100	1" Flanged Check Valve	EACH	\$29.92
			
PPMSV040808W	8mm Shut-off Valve	EACH	\$14.05
			
UV075FP	3/4" Single Union Ball Valve	EACH	\$37.20
			
LL08001	In Line Check Valve	EACH	\$27.05
			
21950-2-NYB	TeeJet 2 PSI end cap	EACH	\$6.95
			
CP21953-VI	Diaph. Viton 21950 Minimum Order 5	EACH	\$2.85
			
L08050	Check Valve Elastomer Boot	EACH	\$5.30
			
CP-C08M	8mm Collet - replacement for manifolds, check valves and 8mm push-in fittings Minimum Order 10	EACH	\$2.30
			
CA-R08M-S	O-ring for check manifolds, check valves and 8mm push-in fittings. Min. Order 20	EACH	\$0.45
			
LM055RED	0.55mm Red Line Meter. Min. Order 10	EACH	\$4.60
			
LM070GRN	0.70mm Green Line Meter. Min. Order 10	EACH	\$4.60
			
LM085BLU	0.85mm Blue Line Meter. Min. Order 10	EACH	\$4.60
			
LM100PUR	1.0mm Purple Line Meter. Min. Order 10	EACH	\$4.60
			

## STACKER DISTRIBUTION SYSTEMS continued

ITEM CODE	DESCRIPTION	UNIT	PRICE
LM110ORN	1.1mm Orange Line Meter. Min. Order 10	EACH	\$4.60
			
LM120YEL	1.2mm Yellow Line Meter. Min. Order 10	EACH	\$4.60
			
LM130WHI	1.3mm White Line Meter. Min. Order 10	EACH	\$4.60
			
LM150PNK	1.5mm Pink Line Meter. Min. Order 10	EACH	\$4.60
			
LM170BLK	1.7mm Black Line Meter. Min. Order 10	EACH	\$4.60
			
LM250GRY	2.5mm Grey Line Meter. Min. Order 10	EACH	\$4.60
			
L08015	1/4" V3 Rubber Union to suit 6.35mm SS Tube. Min. Order 5	EACH	\$6.95
			
<i>Pre 2012 STACKER Terminal Assembly or LQS-ATL4 &amp; LQS-ATL4X Air Seeder Terminal Low Rate Configurations</i>			
L08016	5mm V4 Rubber Union to suit 9.53mm SS Tube. Min. Order 5	EACH	\$6.60
			
<i>LQS-ATST Air Seeder Terminal Standard Rate Configuration</i>			
L08017	6mm V4 Rubber Union to suit 9.53mm SS Tube. Min. Order 5	EACH	\$6.60
			
TSNIP	Tube Cutting Tool	EACH	\$13.20
			
70843	Line Meter Pliers	EACH	\$66.00
			
COM-0013-SM	Line Meter Separator (Compression) Tool	EACH	\$7.25
			
<i>(Use the Compression Tool to depress the Locking Collets on the STACKER Manifold quick release insert cartridges when inserting or extracting the 8.0mm PE tubing.)</i>			
FC100	1" Flange Clamp	EACH	\$18.50
			

PRICES EXCLUDE GST















T: (08) 9362 6811

52











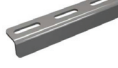

F: (08) 9361 3263

# LIQUID SYSTEMS SPARES

## STACKER DISTRIBUTION SYSTEMS continued

ITEM CODE	DESCRIPTION	UNIT	PRICE
M100G	1" EPDM Gasket ('O'ring)	EACH	\$3.85
			
HB075-90	0° Elbow 3/4" Male Thread x 3/4" Hose Barb	EACH	\$3.20
			
HBT075	3/4" Hose Barb Tee	EACH	\$4.40
			
LL08057	Single Manifold Assembly Includes Lid, 'O' rings & Cartridges, Bolts & Plugs	EACH	\$176.00
			
LL08003	Manifold	EACH	\$106.70
			
L08005	Stainless S Manifold Lid	EACH	\$17.95
			
L08066	Manifold Spacer Plate - 12mm	EACH	\$16.28
			
L08071	Manifold Fitting Gasket Seal	EACH	\$10.60
			
LL08201	3/4" Barb Fitting	EACH	\$10.90
			
LL08202	3/4" Plug Fitting	EACH	\$10.55
			
LL08203	3/4" Nipple Fitting	EACH	\$10.55
			
LIQ21	3/4" BSP Plug	EACH	\$8.70
			
AAB126ML-F75-80	F75-80 Flange Strainer BSPT #80 Mesh Filter Screen	EACH	\$129.80
			
TJ-CP48656-VI	Head gasket for AA 126 Line Strainer AAB126ML-F75-80	EACH	\$17.95
			

## STACKER DISTRIBUTION SYSTEMS continued

ITEM CODE	DESCRIPTION	UNIT	PRICE
CP15941-3-SSPP	50 Mesh Filter Screen for AA126 Line Strainer	EACH	\$37.40
			
CP15941-4-SSPP	80 Mesh Filter Screen for AA126 Line Strainer	EACH	\$37.40
			
CP15941-5-SSPP	100 Mesh Filter Screen for AA126 Line Strainer	EACH	\$37.40
			
M12X250 304 SS AT	M12X250 304 SS All Thread Stud	EACH	\$8.15
			
L08029	Adaptor Angle Bracket	EACH	\$59.40
			
L08023	Universal Manifold Bracket	EACH	\$89.10
			
L08025	Universal Manifold Landing Plate	EACH	\$79.20
			
2003 3/4	S/S BSP Swing Check Valve	EACH	\$48.30
			
505.888.116962	STACKER Dual Scale 10 Bar Back Mount Liquid Systems 3 hole Flange Pressure Gauge	EACH	\$469.70
			
LL08080	STACKER Dual Scale 10 Bar Pressure Gauge Kit Includes bracket and fixings	KIT	\$576.40
			
PM010812E	1/4" BSP 8mm straight adaptor	EACH	\$4.05
			
LL08099	Terminal Jet - Replacement Solution Consists of: 1 x JG-PM0408W (8mm straight joiner) 1 x JG-PM060804E (8mm-4mm stem reducer) 1m x BL-204352 (4mm OD x 1.8mm ID purple tube)	EACH	\$9.00
			
LL08212	Line Locker Minimum Order 5	EACH	\$5.40
			

PRICES EXCLUDE GST

T: (08) 9362 6811

53



F: (08) 9361 3263

# LIQUID SYSTEMS SPARES















## STACKER DISTRIBUTION SYSTEMS continued

ITEM CODE	DESCRIPTION	UNIT	PRICE
204394-200R	6.5mm V5 Rubber Union to suit 9.53mm (3/8") SS Tube & fit Line Locker	EACH	\$6.60
			
204385-03200S	3.0mm OD X 1.2mm ID Orange Terminal Tube. Min. Order 20m	200m roll	\$308.00 \$1.85/m
			
204352-200R	4.0mm OD X 1.8mm ID Purple Terminal Tube Minimum Order 20m	200m roll	\$264.00 \$1.60/m
			
204394-200R	5.0mm OD X 1.2mm ID Yellow Terminal Tube Minimum Order 20m	200m roll	\$396.00 \$2.10/m
			
204390-200R	5.0mm OD X 2.5mm ID Black / Yellow Terminal Tube Minimum Order 20m	200m roll	\$242.00 \$1.30/m
			
204396-200R	6.0mm OD X 4.2mm ID Yellow/ Black Terminal Tube Minimum Order 20m	200m roll	\$308.00 \$1.85/m
			
204402-08200	8mm OD x 5.2mm ID Black / Yellow Delivery Tube	200m roll	\$308.00 \$1.70/m
			
PE-1007-100m-E	10mm OD x 7 mm ID Black Terminal Tube	100m roll	\$242.00 \$2.90/m
			
ST-950 003000	Stainless Steel Sharpener (for chamfering tube)	EACH	\$2.95
			
T006.3CASA	6.3 OD x 1.2 WT 316 SS Seamless Tube	CUT TO SUIT	\$22.30/m \$5.00/cut
			
T009.5DASA	9.5 ODx 1.6W 316 SS Seamless Tube	CUT TO SUIT	\$27.90/m \$5.00/cut
			

## MONITORS, WIRING LOOMS & ELECTRONICS

LL03087	Wika Transducer Assembly AA-WIKA - Transducer Loom, WK-531.0.13066880 - A10 Pressure Transducer	KIT	\$370.70
			
LL03014	Pump RPM Monitoring Kit RPM monitor, AA-C2929 Monitor Loom & Pump RPM Sensor	KIT	\$618.20
			

## MONITORS, WIRING LOOMS & ELECTRONICS continued

ITEM CODE	DESCRIPTION	UNIT	PRICE
LL03016	Pump RPM Monitoring Kit RPM monitor, AA-C2929 Monitor Loom & Pump RPM Sensor	KIT	\$815.10
			
FMD300RPM + L03015	Pump RPM monitor with fascia plate	EACH	\$469.70
			
LL03017	Pump RPM Sensor fan sensor, fan magnet & fixings	KIT	\$196.90
			
C2929	Pump RPM Monitor Loom	EACH	\$134.20
			
L2RCKIT	L2 Rate Controller Kit	KIT	\$4,884.00
			
SP SEN Kit	Ground Speed Sensor Kit (L2 controller)	KIT	\$316.80
			
L2 Harness Assembly	L2 Loom Assembly includes 1 x AA-H1212; 1 x AA-H1213/20M & 1 x H1214	KIT	\$1,914.00
			
H1212	L2 Tractor Loom 10m	EACH	\$772.20
			
X20 Kit	Topcon X20 Loom Kit includes 1 x AA-C2457 & 1 x AA-H1214	KIT	\$1,003.20
			
C2457	Topcon X20 Cross-over Loom	EACH	\$336.60
			
H1213/10M	L2/X20 Extension Loom 10m	EACH	\$477.40
			
H1213/20M	L2/X20 Extension Loom 20m	EACH	\$494.70
			
H1213/2M	L2/X20 Extension Loom 2m	EACH	\$265.10
			
H1213/5M	L2/X20 Extension Loom 5m	EACH	\$324.50
			

PRICES EXCLUDE GST

T: (08) 9362 6811









54

F: (08) 9361 3263





# LIQUID SYSTEMS SPARES

## MONITORS, WIRING LOOMS & ELECTRONICS continued

ITEM CODE	DESCRIPTION	UNIT	PRICE
H1214	L2/X20 Module Loom 10m	EACH	<b>\$666.60</b>
			
TC-1013026-01	Topcon Apollo CM40 Adapter Loom 10m	EACH	<b>\$517.00</b>
			
LL07011	Generic Module Loom (5m)	EACH	<b>\$309.10</b>
			
LL07015	Generic Module Extension (5m)	EACH	<b>\$314.60</b>
			
TC-1013025-01	Topcon Apollo EM24 Sect Adapter Loom	EACH	<b>\$489.50</b>
			
LL07013	Section Loom (7-12 Section 6m)	EACH	<b>\$601.70</b>
			
LL07014	Section Loom Extension (6m)	EACH	<b>\$392.70</b>
			
LL07018	JDRC2000 / Raven RCM Multi-Product Adapter (8 pin)	EACH	<b>\$343.20</b>
			
LL07019	JDRC2000 / Raven RCM Single SC Adapter (47 pin)	EACH	<b>\$421.30</b>
			
LL07020	Generic Module Extension (12m)	EACH	<b>\$372.90</b>
			

## MONITORS, WIRING LOOMS & ELECTRONICS continued

ITEM CODE	DESCRIPTION	UNIT	PRICE
LL07021	Section Loom Extension (12m)	EACH	<b>\$460.90</b>
			
LL07022	JDRC2000 / Raven RCM Multi-Product SC Adapter (8 pin)	EACH	<b>\$342.10</b>
			
LL07023	Section Loom (2-6 Section, 6m)	EACH	<b>\$326.70</b>
			
LL07024	JDRC2000 / Raven RCM Section Splitter	EACH	<b>\$324.50</b>
No image available			
LL07027	Dickey-John IntelliAg Adapter	EACH	<b>\$286.00</b>
No image available			
LL07030	Seedhawk Icon SC Adapter	EACH	<b>\$535.70</b>
No image available			
LL07032	GRC Single Adapter (37 pin)	EACH	<b>\$334.40</b>
No image available			
LL07033	GRC Single SC Adapter	EACH	<b>\$550.00</b>
No image available			
LL07034	Trimble Single SC Adapter Loom	EACH	<b>\$608.30</b>
No image available			

PRICES EXCLUDE GST

T: (08) 9362 6811

55

F: (08) 9361 3263

# HYPRO FLOW CONTROL

## MF-Valveset

Metered flow valve set.  
Suit Hydro centrifugal pump.

\$4,169.00 + GST



METERED FLOW VALVE SET  
(for centrifugal pumps)

## LIQUID SYSTEMS RATE TABLE

	WATER (SG 1.0) l/min											
	0.5 bar	1 bar	1.5 bar	2 bar	2.5 bar	3 bar	3.5 bar	4 bar	4.5 bar	5 bar	5.5 bar	6 bar
★ Red 0.55	0.125	0.160	0.190	0.225	0.255	0.285	0.302	0.315	0.335	0.355	0.360	0.375
★ Green 0.70	0.185	0.255	0.300	0.345	0.385	0.415	0.445	0.465	0.500	0.520	0.560	0.580
★ Blue 0.85	0.310	0.434	0.520	0.610	0.630	0.680	0.730	0.780	0.810	0.830	0.855	0.900
1.0	0.335	0.450	0.530	0.630	0.710	0.760	0.800	0.850	0.890	0.930	0.950	1.000
1.1	0.525	0.640	0.880	1.020	1.110	1.140	1.305	1.350	1.245	1.425	1.480	1.620
★ Yellow 1.2	0.650	0.890	1.050	1.170	1.240	1.280	1.380	1.480	1.500	1.600	1.660	1.740
1.3	1.040	1.480	1.800	2.020	2.160	2.370	2.490	2.650	2.790	2.820	2.970	3.050
1.5	1.200	1.550	1.900	2.100	2.225	2.410	2.525	2.675	2.800	2.850	3.000	3.100
★ Black 1.7	1.600	2.100	2.500	2.625	2.800	3.000	3.175	3.300	3.480	3.600	3.750	3.900
2.0	1.950	2.600	3.100	3.500	3.900	4.100	4.400	4.550	4.850	5.100	5.300	5.600
★ Grey 2.5	2.200	3.250	3.900	4.800	5.200	5.600	6.000	6.400	7.050	7.200	7.800	8.100

	UAN (SG 1.32); 42.5% N (W/V); 32.0% N (W/W) l/min											
	0.5 bar	1 bar	1.5 bar	2 bar	2.5 bar	3 bar	3.5 bar	4 bar	4.5 bar	5 bar	5.5 bar	6 bar
★ Red 0.55	0.115	0.150	0.185	0.210	0.225	0.260	0.270	0.282	0.295	0.305	0.320	0.332
★ Green 0.70	0.245	0.160	0.215	0.255	0.300	0.335	0.357	0.380	0.395	0.420	0.445	0.465
★ Blue 0.85	0.275	0.370	0.450	0.490	0.520	0.560	0.600	0.630	0.660	0.700	0.720	0.740
1.0	0.285	0.380	0.465	0.536	0.580	0.630	0.680	0.720	0.766	0.770	0.814	0.870
1.1	0.400	0.546	0.670	0.740	0.840	0.904	1.035	1.110	1.155	1.206	1.245	1.329
★ Yellow 1.2	0.500	0.670	0.800	0.910	1.000	1.065	1.155	1.215	1.260	1.305	1.335	1.395
1.3	0.950	1.300	1.600	1.800	1.925	2.050	2.175	2.285	2.390	2.500	2.570	2.665
1.5	1.000	1.370	1.650	1.850	2.000	2.100	2.200	2.380	2.500	2.600	2.700	2.765
★ Black 1.7	1.290	1.400	2.000	2.200	2.385	2.500	2.630	2.780	2.900	3.000	3.125	3.200
2.0	1.600	2.250	2.685	3.040	3.290	3.650	3.920	4.100	4.300	4.420	4.600	4.800
★ Grey 2.5	2.100	2.830	3.400	3.850	4.220	4.600	5.000	5.350	5.600	5.830	6.000	6.420

\* LINE METERS AVAILABLE EX STOCK - OTHER SIZES ON REQUEST

### LIQUID SYSTEM LINE METER SELECTION

W = Width of bar / air tool (metres)  
R = Rate (Litre per hectare)  
S = Speed (Kilometres per hour)  
N = Number of outlets

RATE  
(litres per minute per outlet)

$$\frac{W \times R \times S}{600 \times N}$$

RATE  
(litres per minute total)

$$\frac{W \times R \times S}{600}$$

PRICES EXCLUDE GST

T: (08) 9362 6811

56

F: (08) 9361 3263

# CHEMICAL TRANSFER SOLUTIONS

ITEM CODE	DESCRIPTION	UNIT	PRICE	ITEM CODE	DESCRIPTION	UNIT	PRICE
744-409	Micromatic FCC Coupler 3 Pin (Herbicide)	EACH	\$467.00	R1415-X670	Pump and 12 Volt Motor only c/w cable gland	EACH	\$2,268.00
744-408	Micromatic FCC Coupler 4 Pin (Insecticide)	EACH	\$487.00	R1400KTF6863	Service kit to suit 400 Series Sotera Pumps Old style	EACH	\$666.00
744-085	4 Pin (Insecticide)	EACH	\$464.00	R1400KTH1457	Service kit to suit 400B Series Sotera Pumps New style	EACH	\$666.00
729-826	Micromatic Coupler Sevice Kit suits above FCC Couplers	EACH	\$87.00	R1HPNSP	Piston type Hand Pump	EACH	\$384.00
729-848	Suits pree-FCC, older Couplers	EACH	\$96.00	R1HPNSPM	As above with Micromatic Coupler and Rinser	EACH	\$1,059.00
799-010	Coupler Rebuild. 744-408 and 744-409 only	EACH	\$181.00	R1HPNH0	Hose kit (2m) to suit with Nozzle	EACH	\$107.00
2DV3-001	Micromatic Rinser 3 Pin (Herbicide)	EACH	\$188.00	R135LH	Volumetric hand pump one litre. Hose and non- drip nozzle kit	EACH	\$867.00
2DV4-001	Micromatic Rinser 4 Pin (Insecticide)	EACH	\$202.00	R1435	Chemtraveller basic unit with no MM fittings with R1825 Flowmeter	EACH	\$3,198.00
R1825	Sotera electronic flow meter Series 825	EACH	\$679.00	R1435MAB	Chemtraveller Batch Controller with red LED "drum-empty" indicator	EACH	\$5,286.00
R1850	Sotera electronic flow meter Series 850 with Air Elimination	EACH	\$812.00	R1435AB	Chemtraveller Batch as above, NO Micromatic	EACH	\$4,628.00
R1850MKC	Sotera suction meter kit 850 flowmeter	EACH	\$1,301.00	R1825KTF1582	Flowmeter Chamber Assy Repair kit Suit both 825 and 850 series	EACH	\$249.00
R1435MA	Chemtraveller kit with Air Elimination Series 85 meter	EACH	\$3,996.00	R1TT10PB	Turbine Flowmeter Poly, In-line, 25mm, BSP, 8-132 LPM	EACH	\$564.00
R1435M-825	Chemtraveller kit no flowmeter	EACH	\$3,184.00	R1HPNKIT	Pump Repair Kit inc. 4 check valves, Piston Ring, O-Ring, Gasket, Vent Seal	EACH	\$159.00
R1435M	Chemtraveller kit with standard flowmeter and Micromatic fittings	EACH	\$3,853.00	R135LH R135LHM* R135KTF1416**	Hand Pump C/w hose Non-drip nozzle kit and drop tube *as above with Micromatic Vertical outlet coupler and rinser **Pump repair kit inc Barex tube, piston and base O-ring	EACH	\$867.00 \$1,542.00 \$154.00
R1435-825	Chemtraveller kit with no flowmeter or Micromatic fittings	EACH	\$2,529.00	745-7339-4P	Closed Mixing System For use with 1,000L IBC	EACH	\$5,205.00
R1435A	Chemtraveller kit with Air Sensing flowmeter but no Micromatic fittings	EACH	\$3,341.00	745-7430-4P	For use with "Envirodrums" and similar fitted with Drum Valves	EACH	\$3,335.00

PRICES EXCLUDE GST

T: (08) 9362 6811

57

F: (08) 9361 3263

# SHURflo 12, 24 and 240 VOLT PUMPS

SHURflo offers a broad range of pumps to suit markets as diverse as agriculture, water transfer, carpet cleaning and a range of industrial applications. Shurflo has a strong reputation as a market leader in reliable cost effective pumping solutions.

MODEL	VOLT	OPEN FLOW	VALVE	DIAPH.	DRAW MAX	PORTS	MAX PRESS	PRESS Sw.	LIST
-------	------	-----------	-------	--------	----------	-------	-----------	-----------	------

### SLV SERIES

SLV10AA40	12	3.8	V	S	2.5	3/8" barb	40	Y	\$159.00
-----------	----	-----	---	---	-----	-----------	----	---	----------

### 8000 SERIES

8000-543-136	12	6.8	V	S	7.3	1/2" male	60	Y	\$235.00
8000-543-138	12	6.8	V	S	8.7	1/2" male	100	Y	\$265.00
8000-043-235	12	6.8	V	GEO	7	3/8" fem	50	Y	\$395.00
8000-547-189	12	6.6	V	S	7.3	1/2" male	107	Y	\$215.00
8090-902-278	240	5.4	E	S	0.33	3/8" fem	100	Y	\$399.00
8006-294-210	12	3.8	E	S	3.2	3/8" fem	35	N	\$255.00

### 2088 SERIES

2088-343-135	12	11.3	V	S	10.1	1/2" male	45	Y	\$275.00
2088-313-145*	12	13.6	V	S	10.1	1/2" male	45	Y	\$495.00
2088-474-144	24	11.4	S	S	2.73	1/2" male	45	Y	\$299.00

\*Premium pump fin cooled for heavy duty applications

### 4009 SERIES POTABLE WATER

4009-101-B87	12	11.3	E	S	5.2 A	1/2" male	45	Y	\$195.00
--------------	----	------	---	---	-------	-----------	----	---	----------

### 5000 SERIES

5059-3611	12	20.1	V	S	21 A	1/2" male	90	N	\$415.00
5059-1310	12	20.1	V	S	21	1/2" male	60	Y	\$415.00

### SWIVEL FITTINGS

SHURflow swivel fittings make it an easy task to remove pump hoses for servicing and maintenance.

MODEL	BARB	LIST	MODEL	BARB	LIST
234-3916	ELBOW 3/8"	5.50	234-2916	STRAIGHT 3/8"	\$5.50
234-3926	ELBOW 1/2"	5.50	234-2926	STRAIGHT 1/2"	\$5.50
234-3946	ELBOW 3/4"	5.50	234-2946	STRAIGHT 3/4"	\$5.50



SLV



8000 Male Ports



8000 Female Ports



2008 Series



4009 Series



5000 Series

PRICES EXCLUDE GST

T: (08) 9362 6811

58

F: (08) 9361 3263

## CENTRIFUGAL PUMPS

MODEL	DESCRIPTION	MAX CAP	MAX PRESSURE	PORTS IN	OUT	LIST
-------	-------------	---------	--------------	----------	-----	------

### SERIES 9000 GEAR DRIVEN PUMPS

9006C	Cast iron w/1 3/8" 540 RPM Hub and Locking Collar Kit (6 Spline)	442 LPM	5 Bar	1 1/2"	1 1/4"	\$2035.00
-------	--	---------	-------	--------	--------	-----------

### SERIES 9200 PEDESTAL MODELS CAST & S/STEEL

9203C	Pedestal Centrifugal	530 LPM	11 Bar	1 1/2"	1 1/4"	\$785.00
9203C-R	Pedestal Centrifugal Reverse Rotation (Suit most spray coupe)	530 LPM	11 Bar	1 1/2"	1 1/4"	\$785.00
9203S	Pedestal Centrifugal Stainless	530 LPM	11 Bar	1 1/2"	1 1/4"	\$1595.00
9203S-R	Centrifugal Reverse Rotation Stainless Steel/Lifeguard Seals	530 LPM	11 Bar	1 1/2"	1 1/4"	\$1595.00
9206S	Pedestal Centrifugal S/Steel L/G Seal	856 LPM	5.5 Bar	2"	1 1/2"	\$1855.00
9205C	Pedestal Centrifugal	680 LPM	13 Bar	2"	1 1/2"	\$1755.00

### SERIES 9200 PEDESTAL MODELS – 12 VOLT CLUTCH

9263C-C	Centrifugal C/W 12 V Clutch	530 LPM	8 Bar	1 1/2"	1 1/4"	\$1645.00
9263C-CR	Centrifugal C/W 12 V Clutch Reverse Rotation	530 LPM	8 Bar	1 1/2"	1 1/4"	\$1645.00
9263S-C	Centrifugal (Stainless) C/W 12 V Clutch	530 LPM	8 Bar	1 1/2"	1 1/4"	\$2595.00
9263S-CR	Centrifugal (Stainless) C/W 12 V Clutch Reverse Rotation	530 LPM	8 Bar	1 1/2"	1 1/4"	\$2595.00

### SERIES 9200 SELF PRIMING PEDESTAL MODEL

9203C-SP	Centrifugal w/Self Prime Chamber	462 LPM	10 Bar	1 1/2"	1 1/4"	\$1315.00
9203C-R-SP	Centrifugal w/Self Prime Chamber Reverse Rotation	462 LPM	10 Bar	1 1/2"	1 1/4"	\$1315.00
9205C-BSP	Centrifugal w/Self Prime Chamber	617 LPM	8 Bar	2"	2"	\$2375.00

### POLYPROPYLENE PEDESTAL AND HYDRAULIC DRIVE

9203P-S	Pedestal Centrifugal	386 LPM	5.5 Bar	1 1/2"	1 1/4"	\$975.00
9303P-HM1C	Centrifugal Hydraulic Drive HM1	412 LPM	8 Bar	1 1/2"	1 1/4"	\$1725.00
9303P-HM2C	Centrifugal Hydraulic Drive HM2	302 LPM	5.5 Bar	1 1/2"	1 1/4"	\$1725.00
9303P-HM4C	Centrifugal Hydraulic Drive HM4	302 LPM	5.5 Bar	1 1/2"	1 1/4"	\$1725.00
9303P-HM5C	Centrifugal Hydraulic Drive HM5	428 LPM	7.5 Bar	1 1/2"	1 1/4"	\$1725.00



9006C



9203C



9206S



9263C-C



9203C-SP



9203P

PRICES EXCLUDE GST

## CENTRIFUGAL PUMPS

HYPRO hydraulically driven centrifugal pumps are widely adaptable for a range of spraying and industrial requirements. They are suitable for use with both open and closed tractor hydraulic systems and a range of motor options are available to ensure the pump suits your hydraulic system. Hypro has a detailed hydraulic selection guide (Form 270) to help in correct pump selection. Hypro recommends the use of a free return to tank system on the hydraulic return line to minimise back pressure to the hydraulic motor. Pumps come standard with a hydraulic non return valve and bypass adjustment screw as well as a comprehensive installation manual.

MODEL	DESCRIPTION	MAX CAP	MAX PRESSURE	PORTS IN	OUT	LIST
<b>SERIES 9000 CAST IRON HYDRAULICALLY DRIVEN</b>						
9303C-HM2C	Hydraulic Pump (Oil Flow 15-22 LPM)	356 LPM	5.5 Bar	1 1/2"	1 1/4"	\$1465.00
9303C-HM4C	Hydraulic Pump (Oil Flow 19-26 LPM)	416 LPM	6.2 Bar	1 1/2"	1 1/4"	\$1465.00
9303C-HM4C-U	Flanged 220 x 200 (19-26 LPM)	416 LPM	6.2 Bar	220	200	\$1595.00
9303C-HM1C	Hydraulic Pump (Oil Flow 41-49 LPM)	424 LPM	8.2 Bar	1 1/2"	1 1/4"	\$1465.00
9303C-HM1C-U	Flanged 220 x 200 (41-49 LPM)	424 LPM	8.3 Bar	220	200	\$1595.00
9303C-HM5C	Hydraulic Pump (Oil Flow 56-64 LPM)	549 LPM	9.6 Bar	1 1/2"	1 1/4"	\$1465.00
9303C-HM3C	Hydraulic Pump (Oil Flow 57-76 LPM)	473 LPM	5.5 Bar	1 1/2"	1 1/4"	\$1795.00
9305C-HM3C	Hydraulic Pump (Oil Flow 57-76 LPM)	685 LPM	12.4 Bar	2"	1 1/2"	\$2515.00
9306C-HM1C	Hydraulic Pump (Oil Flow 41-49 LPM)	784 LPM	8.2 Bar	2"	1 1/2"	\$1755.00
9306C-HM1C-U	Flanged 220 x 200 (41-49 LPM)	784 LPM	8.2 Bar	220	220	\$1895.00
9306C-HM5C	Hydraulic Pump (Oil Flow 56-64 LPM)	803 LPM	9 Bar	2"	1 1/2"	\$1755.00
9306C-HM5C-U	Flanged 220 x 200 (56-64 LPM)	803 LPM	9 Bar	220	220	\$1895.00
9306C-HM5C-3U	Flanged 300 x 220 (56-64 LPM)	1181 LPM	9 Bar	300	220	\$2110.00
9306C-HM3C	Hydraulic Pump (Oil Flow 68-90 LPM)	810 LPM	9 Bar	2"	1 1/2"	\$2195.00
9307C-GM10	Hydraulic Pump (Oil Flow 60-83 LPM)	1390 LPM	9 Bar	3"	2"	\$6985.00

-U denotes Flanged -3U denotes 3 inch Flanged



9303C



9306C



9306C-U



9307C



### FLANGED FACED PUMPS

Flanged faces (Banjo type) are available for most models. For ordering use suffix -U. For example 9303C-HM4C with flanged face is 9303C-HM4C-U.

Please note: 3 inch flanges are available for 9306 models

PRICES EXCLUDE GST

T: (08) 9362 6811

60

F: (08) 9361 3263

## CENTRIFUGAL PUMPS

HYPRO stainless steel centrifugal pumps are made with 316 stainless steel casings for improved durability and tremendous resistance to aggressive solutions. HYPRO stainless steel pumps are fitted standard with HYPRO LIFEGUARD seals which are silicon carbide based and possess 21 times the dry run survivability of standard seals and 8 times the life in abrasive solutions when compared to standard seals. Hypro recommends the use of a free return to tank system on the hydraulic return line to minimise back pressure to the hydraulic motor.

MODEL	DESCRIPTION	MAX CAP	MAX PRESSURE	PORTS IN	OUT	LIST
<b>SERIES 9000 STAINLESS STEEL HYDRAULICALLY DRIVEN</b>						
9303S-HM2C	Hydraulic Pump (Oil Flow 15-22 LPM)	356 LPM	5.5 Bar	1 1/2"	1 1/4"	\$2595.00
9303S-HM4C	Hydraulic Pump (Oil Flow 19-26 LPM)	416 LPM	6.2 Bar	1 1/2"	1 1/4"	\$2595.00
9303S-HM4C-U	Flanged 220 x 200 (19-26 LPM)	416 LPM	6.2 Bar	220	200	\$2855.00
9303S-HM1C	Hydraulic Pump (Oil Flow 41-49 LPM)	424 LPM	8.3 Bar	1 1/2"	1 1/4"	\$2595.00
9303S-HM1C-U	Flanged 220 x 200 (41-49 LPM)	424 LPM	8.3 Bar	220	200	\$2855.00
9303S-HM5C	Hydraulic Pump (Oil Flow 56-64 LPM)	549 LPM	9 Bar	1 1/2"	1 1/4"	\$2595.00
93095 (HM1C)	Hydraulic Pump (Oil Flow 41-49 LPM)	784 LPM	8.2 Bar	2"	1 1/2"	\$2895.00
9306S-HM1C-U	Flanged 220 x 200 (41-49 LPM)	784 LPM	8.2 Bar	220	220	\$3150.00
9306S-HM5C-003	Hydraulic Pump (Oil Flow 56-64 LPM)	803 LPM	9 Bar	2"	1 1/2"	\$2895.00
9306S-HM5C-U	Flanged 220 x 200 (56-64 LPM)	803 LPM	9 Bar	220	200	\$3150.00
9306S-HM5C-3U	Flanged 300 x 220 (56-64 LPM)	1200 LPM	9 Bar	300	200	\$3650.00
9306S-HM3C	Hydraulic Pump (Oil Flow 68-90 LPM)	810 LPM	9 Bar	2"	1 1/2"	\$3350.00
9306S-HM3C-3U	Flanged 300 x 220 (68-90 LPM)	1200 LPM	9 Bar	2"	1 1/2"	\$3945.00

-U denotes Flanged



9303S Flanged



9306S  
2" x 1.5"



9306S-HM5C-3U

PRICES EXCLUDE GST

## CENTRIFUGAL PUMPS

HYPRO hydraulically driven centrifugal pumps are widely adaptable for a range of spraying and industrial requirements. They are suitable for use with both open and closed tractor hydraulic systems and a range of motor options are available to ensure the pump suits your hydraulic system. Hypro has a detailed hydraulic selection guide (Form 270) to help in correct pump selection. Hypro recommends the use of a free return to tank system on the hydraulic return line to minimise back pressure to the hydraulic motor. Pumps come standard with a hydraulic non return valve and bypass adjustment screw as well as a comprehensive installation manual.

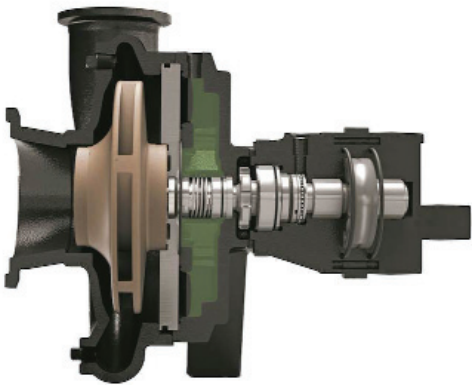

### HYDRO FORCEFIELD WET SEAL TECHNOLOGY

- Forcefield Technology is a superior wet seal technology that provides the ultimate protection for the mechanical seal and avoids costly downtime
- Protects the mechanical seal against common failures related to dry run and chemical bonding by using a barrier fluid to keep it cool and lubricated
- Mechanical seal is contained in a fluid chamber and does not come into contact with applied chemical or run dry
- Actively maintains a pressure differential between the barrier fluid and the pumping solution, which results in longer life and worry free operation
- Designed to be a drop-in replacement for standard Hypro hydraulically driven centrifugal pumps
- Heavy duty hydraulic motor with large motor bearing

MODEL	DESCRIPTION	HYD FLOW LPM	MAX CAP	MAX PRESS	PORTS IN	OUT	LIST
9313CU-M08	Forcefield Flanged Cast Iron Equivalent 9303C-HM1C-U	41-50	625 LPM	9 Bar	220	200	\$2935.00
9313SU-M08	Forcefield Flanged STAINLESS Equivalent 9303C-HM1C-U	41-50	625 LPM	9 Bar	220	200	\$3975.00
9314CU-M10	Forcefield Flanged Cast Iron Equivalent 9306C-HM5C-U	56-64	882 LPM	9 Bar	220	200	\$2995.00
9314SU-M10	Forcefield Flanged Stainless Equivalent 9306C-HM5C-U	56-64	882 LPM	9 Bar	220	200	\$4570.00

MODEL	DESCRIPTION	MAX CAP	MAX PRESSURE	PORTS IN	OUT	LIST
-------	-------------	---------	--------------	----------	-----	------

### SERIES 9000 SELF PRIMING CAST IRON & STAINLESS STEEL

9303C-HM2C SP	Hyd. Driven Pump (Oil Flow 15-22 LPM)	370 LPM	4.8 Bar	1 1/2"	1 1/4"	\$2340.00
9303S-HM2C SP	Hyd. Driven Pump (Oil Flow 15-22 LPM)	370 LPM	4.8 Bar	1 1/2"	1 1/4"	\$3825.00
9303C-HM4C SP	Hyd. Driven Pump (Oil Flow 19-26 LPM)	363 LPM	5.5 Bar	1 1/2"	1 1/4"	\$2340.00
9303S-HM4C SP	Hyd. Driven Pump (Oil Flow 19-26 LPM)	363 LPM	5.5 Bar	1 1/2"	1 1/4"	\$3825.00
9303C-HM1C SP	Hyd. Driven Pump (Oil Flow 41-49 LPM)	460 LPM	7.6 Bar	1 1/2"	1 1/4"	\$2340.00
9303C-HM5C SP	Hyd. Driven Pump (Oil Flow 56-64 LPM)	460 LPM	7.6 Bar	1 1/2"	1 1/4"	\$2340.00
9303S-HM5C SP	Hyd. Driven Pump (Oil Flow 56-64 LPM)	460 LPM	7.6 Bar	1 1/2"	1 1/4"	\$3825.00
9305C-HM3C SP (9305C-HM3C-SP-004)	Hyd. Driven Pump (Oil Flow 64-72 LPM)	650 LPM	9.6 Bar	2"	2"	\$3425.00



9303C-SP



9305C-SP

PRICES EXCLUDE GST

T: (08) 9362 6811

62

F: (08) 9361 3263



## PUMPING EQUIPMENT

ENGINE	HP	SINGLE IMPELLER O/N	TWIN IMPELLER O/N	INLET BSP	OUTLET BSP
<b>DAVEY PUMP FIREFIGHTER</b>					
BARE SHAFT	N/A	5150P	5250P	1 1/2"	2 X 1 1/2", 2 X 1"
WET END REPLACEMENT SUIT ALL 51 & 52 CODED PUMPS	N/A	5158C	5258C	1 1/2"	2 X 1 1/2", 2 X 1"
HONDA GX160	5.5	5155H	5255H	1 1/2"	2 X 1 1/2", 2 X 1"
BRIGGS & STRATTON	6.0	5160B	5260B	1 1/2"	2 X 1 1/2", 2 X 1"
HONDA GX200	6.5	5165H	5260B	1 1/2"	2 X 1 1/2", 2 X 1"
HONDA GX200 ELECTRIC START	6.5	5165HE	5265HE	1 1/2"	2 X 1 1/2", 2 X 1"
YANMAR DIESEL ELECTRIC START C/W FRAME	7.0	5170YE	5270YE	1 1/2"	2 X 1 1/2", 2 X 1"
<b>DAVEY PUMP FIREFIGHTER PRO</b>					
HONDA GX390 ELECTRIC START	13.0	5113HE	5213HE	2"	1 X 2", 2 X 1"
YANMAR DIESEL ELECTRIC START C/W FRAME	10.0	N/A	5210YE/HP	2"	1 X 2", 2 X 1"



5150P



5155H



5265H



5170YE



5210YE



PRICES EXCLUDE GST

T: (08) 9362 6811

63

F: (08) 9361 3263

# PUMPING EQUIPMENT

ORDER NO	ENGINE	DESCRIPTION	SEALS	INLET BSP	OUTLET BSP
<b>FLEX-N POLY BANJO PUMPS</b>					
205POV-GX200	HONDA GX200	BANJO 2" POLY PUMP THREADED	VITON	2"	2"
205POV-CH260	KOHLER CH260	BANJO 2" POLY PUMP THREADED	VITON	2"	2"
300POV GX200	HONDA GX200	BANJO 3" POLY PUMP THREADED	VITON	3"	3"
300POV CH260	KOHLER CH260	BANJO 3" POLY PUMP THREADED	VITON	3"	3"
M300POV GX200	HONDA	BANJO 3" POLY PUMP FLANGED	VITON	3"	3"

## FLEX-N POLY PACER PUMPS

AGP50H-PV	HONDA GX200	POLY PACER WITH 706 IMPELLER	VITON	2"	2"
AGP50H-PVF	HONDA GX200	POLY PACER WITH 706 IMPELLER C/W FRAME	VITON	2"	2"
AG50-PV	N/A	POLY PACER WITH 706 IMPELLER WET END SUIT MOTOR SHAFT 3/4"	VITON	2"	2"
AG50-PMV	N/A	POLY PACER WITH 706 IMPELLER BARE SHAFT 3/4"	VITON	2"	2"
AGP80H-PV	HONDA GX200	POLY PACER WITH 706 IMPELLER	VITON	3"	3"
AGP80H-PVF	HONDA GX200	POLY PACER WITH 706 IMPELLER C/W FRAME	VITON	3"	3"
AG80-PV	N/A	POLY PACER WITH 706 IMPELLER WET END SUIT MOTOR SHAFT 3/4"	VITON	3"	3"
AG80-PMV	N/A	POLY PACER WITH 706 IMPELLER BARE SHAFT 3/4"	VITON	3"	3"
AGKIT32	N/A	SEAL KIT TO SUIT 2 & 3" POLY PACER PUMPS	VITON	N/A	N/A

## FLEX-N POLY PACER HYDRAULIC DRIVEN PUMP

FWH50-PV		PACER HYD. DRIVEN PUMP 36 LITRES @ 1550 PSI	VITON	2"	2"
FWH80-PV		PACER HYD. DRIVEN PUMP 36 LITRES @ 1550 PSI	VITON	3"	3"

## ALUMINIUM TRANSFER PUMPS

AGP50H	5.5HP HONDA	ALUMINIUM TRANSFER PUMP	EDPM	2"	2"
AGP50H-F	5.5HP HONDA	ALUMINIUM TRANSFER PUMP C/W FRAME	EDPM	2"	2"
AGP80H	5.5HP HONDA	ALUMINIUM TRANSFER PUMP	EDPM	3"	3"
AGP80H-F	5.5HP HONDA	ALUMINIUM TRANSFER PUMP C/W FRAME	EDPM	3"	3"



AGP80H-PV



AGP80H-F



POLY PACER 2 INCH PUMPS



5170Y MOUNTED ON ARMY DUCK

## DAVEY ISO SPEC PUMPS

USED IN A RANGE OF APPLICATIONS:

- RURAL IRRIGATION
- PRESSURE BOOSTING
- FIRE SERVICES
- COMMERCIAL POOLS



PRICES EXCLUDE GST

T: (08) 9362 6811

64

F: (08) 9361 3263

# COMPACT FIRE FIGHTING UNITS

Quality fire fighting units that are made in W.A., these heavy duty poly tanks have the highest UV resistance. Different designs to suit specific applications. Quality trouble free hose reel with 33m of fire hose and nozzle. All units fully tested and ready to go.

## Original Compact Units - AC

Designed to fit across a standard Ute tray, leaves over half the ute tray free to use. Keeps the load forward of the rear axle. Reel and motor on the drivers side for easy access. Galvanised SHS frame. Tank has full draining sump to suit chemical applications

- 500L - 1720mm W x 870mm L x 960mm H
- 800L - 1740mm W x 870mm L x 960mm H

3 Way suction includes 6m of suction line with strainer and camlock connection. Standard with Honda GX160 5.5hp coupled with Davey Single Impeller Pump.



CODE	DESCRIPTION	PRICE
AC500C	500LT COMPACT UNIT FULLY PLUMBED STANDARD	\$3,440
AC500C3W	500LT COMPACT UNIT FULLY PLUMBED 3WAY SUCTION	\$3,630
AC800C	800LT COMPACT UNIT FULLY PLUMBED STANDARD	\$3,680
AC800C3W	800LT COMPACT UNIT FULLY PLUMBED 3WAY SUCTION	\$3,880



PRICES EXCLUDE GST

T: (08) 9362 6811

65

F: (08) 9361 3263

# COMPACT FIRE FIGHTING UNITS

Quality fire fighting units that are made in W.A., these heavy duty poly tanks have the highest UV resistance. Different designs to suit specific applications. Quality trouble free hose reel with 33m of fire hose and nozzle. All units fully tested and ready to go.

## Diesel Powered Skid - AD

Electric start 5hp diesel powered engine, suitable for Mine site application. Fitted with a spill tray. Galvanised Angle steel frame. Tank has full draining sump to suit chemical applications.

- 1000L - 1800mm W x 1185mm L x 1030mm H
- 1200L - 2250mm W x 1300mm L x 700mm H
- 1600L - 2250mm W x 1300mm L x 1100mm H

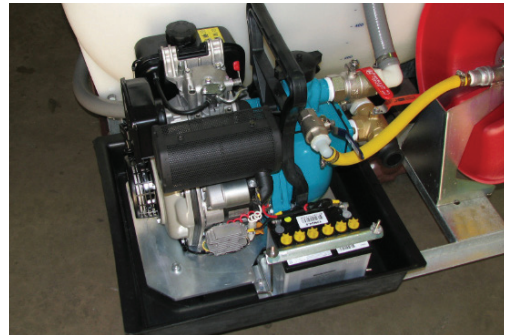

CODE	DESCRIPTION	PRICE
AD1000	1000LT DIESEL SKID UNIT FULLY PLUMBED STANDARD	\$7,135.00
AD1200	1200LT DIESEL SKID UNIT FULLY PLUMBED STANDARD	\$8,195.00
AD1600	1600LT DIESEL SKID UNIT FULLY PLUMBED STANDARD	\$8,495.00



PRICES EXCLUDE GST

T: (08) 9362 6811

66

F: (08) 9361 3263

# COMPACT FIRE FIGHTING UNITS

Quality fire fighting units that are made in W.A., these heavy duty poly tanks have the highest UV resistance. Different designs to suit specific applications. Quality trouble free hose reel with 33m of fire hose and nozzle. All units fully tested and ready to go.

## Skid Units - AE

600L, 800L, 1000L, 1200L, 1600L, 2000L. Flooded suction to the pump. Zinc coated frame.

- 600L - 1800mm L x 1185mm W x 700mm H
- 800L - 1800mm L x 1185mm W x 700mm H
- 1000L - 1800mm L x 1185mm W x 1030mm H

3 Way suction includes 6m of suction line with strainer and camlock connection. Standard with Honda GX160 5.5hp coupled with Davey Single Impeller Pump.

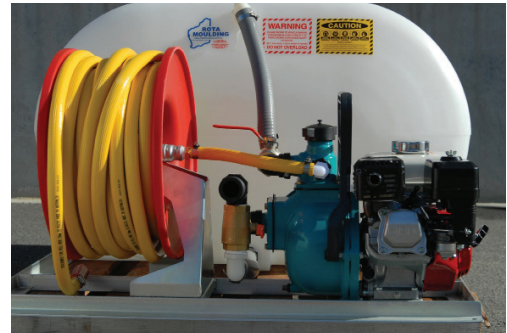

CODE	DESCRIPTION	PRICE
AE600C	600LT ECO UNIT FULLY PLUMBED	\$3,000.00
AE600C3W	600LT ECO UNIT FULLY PLUMBED WITH 3 WAY SUCTION	\$3,490.00
AE800C	800LT ECO UNIT FULLY PLUMBED	\$3,120.00
AE800C3W	800LT ECO UNIT FULLY PLUMBED WITH 3 WAY SUCTION	\$3,600.00
AE1000C	1000LT ECO UNIT FULLY PLUMBED	\$3,250.00
AE1000C3W	1000LT ECO UNIT FULLY PLUMBED WITH 3 WAY SUCTION	\$3,730.00

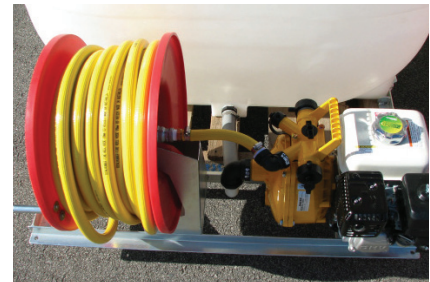

PRICES EXCLUDE GST

T: (08) 9362 6811

67

F: (08) 9361 3263

# DAVEY REMOTE START FIREFIGHTER

## WHY CHOOSE THE DAVEY REMOTE START FIREFIGHTER?

For added security in a bushfire situation, or to eliminate travel time to a remotely located pump, the Davey Remote Start Firefighter provides a number of options for starting and stopping; manually, remotely via SMS or automatically.

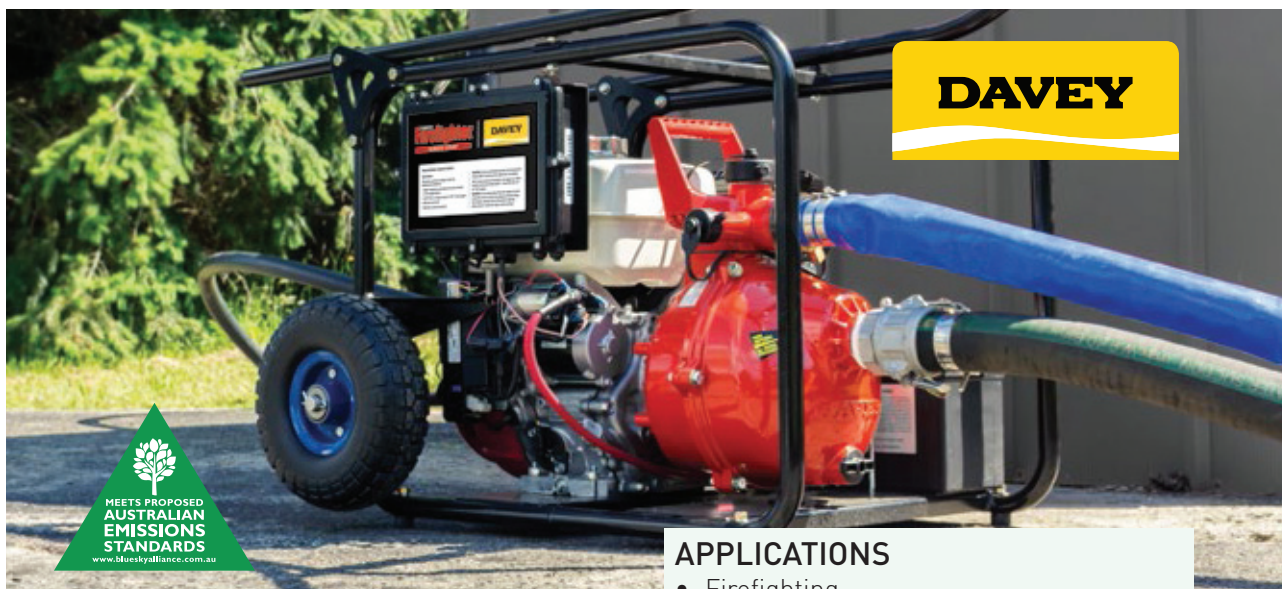

Start options are:

- Electric (via key switch) or recoil starter
- SMS start (subject to subscription and reception)
  - Immediate, delayed start or timed run
- Heat sensors (Davey optional accessory P/N: 402939)
- Remote switch, e.g. float switch, panic button in house, etc.

The pump unit can only be stopped by the following methods:

- Key switch on engine turned to OFF position
- SMS stop signal or SMS timed run expired
- Engine stop due to no fuel remaining or oil alert system shut down.

Multiple users can be registered to operate and receive SMS feedback.

All registered users receive SMS feedback and warnings, such as:

- Pump Start and Pump Stop
- Battery Low
- General Status
- Engine Service and SIM Subscription reminders.

The SIM in the unit's control centre is factory fitted and ready to use utilising the Telstra 3G network across Australia. Ongoing use of the SMS function is subject to reception and subscription status.

## APPLICATIONS

- Firefighting
- External home fire protection sprinkler systems
- Tanker to tanker water transfer
- High head general water transfer
- Irrigation

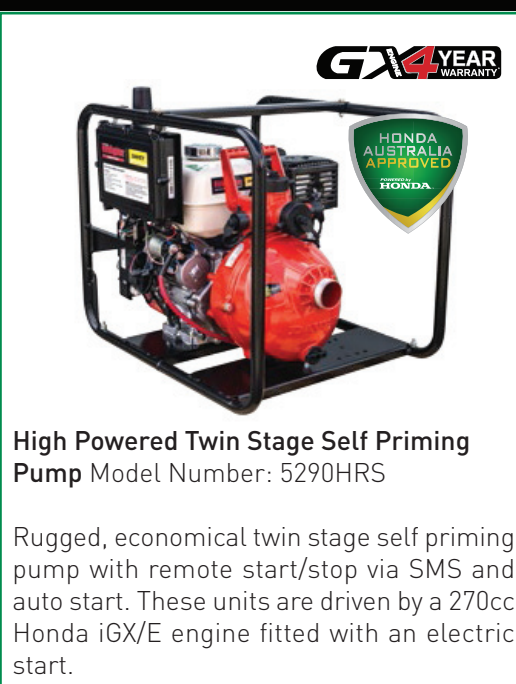

## High Powered Twin Stage Self Priming Pump Model Number: 5290HRS

Rugged, economical twin stage self priming pump with remote start/stop via SMS and auto start. These units are driven by a 270cc Honda iGX/E engine fitted with an electric start.

PRICES EXCLUDE GST

T: (08) 9362 6811

68

F: (08) 9361 3263

# PUMPING SPARES

ITEM CODE	DESCRIPTION	PRICE	ITEM CODE	DESCRIPTION	PRICE
AGFS1000	STANDARD SKID TO SUIT 800 /1000 TANK		1061	PLASTIC 3/4" LUMP END	
					
AGFS500	STANDARD SKID TO SUIT 500L TANK		YHNP075	PLASTIC RED 3/4" FIRE HOSE NOZZLE	
					
AGFS800C	SKID TO SUIT COMPACT 800L		YHNP100	PLASTIC RED 1" FIRE HOSE NOZZLE	
					
SP1000	REPLACEMENT 1000L TANK		YHNB075	BRASS 3/4" FIRE NOZZLE	
					
SP800	REPLACEMENT 800L TANK		YHNB100	BRASS 1" FIRE NOZZLE	
					
SP500	REPLACEMENT 500L TANK		YHRMN075	3/4" RUBBER MOULDED NOZZLE BRASS	
					
FC800	REPLACEMENT 800L COMPACT TANK		YHRMN100	1" RUBBER MOULDED NOZZLE BRASS	
					
AGHR025	METAL STANDARD HOSE REEL		YHNBV075	3/4" BALL VALVE HOSE NOZZLE BRASS	
					
AGHRC019	HOSE REEL SUIT COMPACT UNITS		YHNBV100	1" BALL VALVE HOSE NOZZLE BRASS	
					
YBVML3150	3 WAY BRASS BALL VALVE L PORT		YHNAS100	BLUE ANKA NOZZLE 3/4"	
YBVMT3150	3 WAY STAINLESS BALL VALVE T PORT		YHNAS150	BLUE ANKA NOZZLE 1"	
YBVMF100	METAL BALL VALVE 1"		YHNPJ100	RED POWERJET NOZZLE 1"	
					
YBVMF150	METAL BALL VALVE 1 1/2"		YHNPJ150	RED POWERJET NOZZLE 1 1/2"	
					
YBVMF200	METAL BALL VALVE 2"		<b>BIC COUPLINGS</b>		
					
YLE075	BRASS 3/4" LUMP END				
					

	THREAD SIZE	BRASS	ALUMINIUM	PRICE
<b>BIC MALE X FEMALE BSP</b>				
	1.1/2"	BIC-BR-A038	BIC-AL-A038	
	2"	BIC-BR-A050	BIC-AL-A050	
	2.1/2"	BIC-BR-A063	BIC-AL-A063	

PRICES EXCLUDE GST





T: (08) 9362 6811

69

F: (08) 9361 3263

# PUMPING SPARES

## BIC COUPLINGS *continued*

	THREAD SIZE	BRASS	ALUMINIUM
<b>BIC FEMALE x HOSE TAIL</b> 	1.1/2"	BIC-BR-C038	BIC-AL-C038
	2"	BIC-BR-C050	BIC-AL-C050
	2.1/2"	BIC-BR-C063	BIC-AL-C063
<b>BIC FEMALE x FEMALE BSP</b> 	1.1/2"	BIC-BR-D038	BIC-AL-D038
	2"	BIC-BR-D050	BIC-AL-D050
	2.1/2"	BIC-BR-D063	BIC-AL-D063
<b>BIC MALE x HOSE TAIL</b> 	1.1/2"	BIC-BR-E038	BIC-AL-E038
	2"	BIC-BR-E050	BIC-AL-E050
	2.1/2"	BIC-BR-E063	BIC-AL-E063
<b>BIC MALE x MALE BSP</b> 	1.1/2"	BIC-BR-F038	BIC-AL-F038
	2"	BIC-BR-F050	BIC-AL-F050
	2.1/2"	BIC-BR-F063	BIC-AL-F063
<b>BIC CAP (FEMALE)</b> 		BIC-BR-CAP	BIC-AL-CAP
<b>BIC CAP (FEMALE)</b> 		BIC-BR-CAP	BIC-AL-CAP
<b>BIC WASHER BUNA</b> 		BIC-BUNA-WASH	
<b>UNITED FIRE SAFETY NOZZLES</b> 			
THREAD SIZE	PART NUMBER	MATERIAL	COLOUR
3/4"	618-040	POLYCARBONATE	RED
1"	618-050	POLYCARBONATE	RED
1.1/2"	618-055	POLYCARBONATE	RED
1.1/2"	618-045	PVC	GREEN
1.1/2"	618-056	BRONZE	BRONZE

## BLACKOUT NOZZLES



THREAD SIZE	PART NUMBER	MATERIAL	COLOUR
3/4"	FD20		
1"	FD25		
1 1/2"	FD38		

## HEAVY DUTY WASHDOWN GUNS

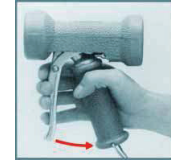
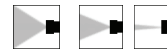

THREAD SIZE	PART NUMBER	COLOUR
1/2"	618-000	BLUE
1/2"	618-000-S	RED

## GARDEN WASHDOWN GUNS



12MM	618-026
18MM	618-027

## BRASS VALVE DIRECTOR

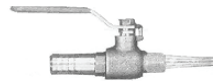

3/4"	618-095
1"	618-096

## FIRE NOZZLE DIRECTOR



3/4"	618-G20
------	---------

ORDER NO	DESCRIPTION	SPECIFICATIONS
<b>STRIKER FIRE MONITORS</b>		
STKR38	STRIKER 38MM FIRE MONITOR	316 STAINLESS, SEALS NITRILE SYNTHETIC RUBBER
STKR50	STRIKER 50MM FIRE MONITOR	316 STAINLESS, SEALS NITRILE SYNTHETIC RUBBER
<b>MASTER STREAM NOZZLES</b>		
STKR818	ALLOY NOZZLE	170 L/MIN @ 100 PSI
STKR819	ALLOY NOZZLE	475 L/MIN @ 100 PSI
STKR820	ALLOY NOZZLE	1325 L/MIN @ 100 PSI
STKR820BC	BRONZE NOZZLE	1325 L/MIN @ 100 PSI

PRICES EXCLUDE GST

T: (08) 9362 6811

70

F: (08) 9361 3263



# ACCUFIRE FIRE UNITS

ACCUFIRE flamethrowers are small, utility mounted flamethrowers that enable farm, forest and rangeland managers to efficiently ignite large tracts of target flammable vegetation quickly, safely and remotely from the cabin of a utility vehicle.

## ACCUFIRE FOREST FIRELIGHTER ACCFF

Used by land managers whose focus is on routine hazard reduction burning of flammable forest vegetation and rangeland grass vegetation.

Let ACCUFIRE introduce you to comfort, speed and efficiency with:

- In-cab switch control for fire on / fire off
- Quick-tatch to utility dropside/frame mount
- Obstacle flick past spring loaded swingarm
- Compact size for convenient lifting and locating
- Ambidextrous for LH or RH drive
- Adjustable angle depending on speed or cast distance
- Operates in forward and reverse
- Auxiliary long range fuel tank as standard
- Fuel and gas efficient
- Hands free, stress free



## ACCUFIRE BROADACRE FIRELIGHTER ACCBF

Popular with Australia's farmland managers whose focus is on the removal of windows, chaff heaps and residual stubble material with harvest weed seed management in mind.

Let ACCUFIRE introduce you to comfort, speed and efficiency with:

- In-cab switch control for fire on / fire off (windows up, no more dead arm)
- Quick-tatch to utility dropside
- Fast ground speed capability
- Fuel and gas efficient
- Operates in forward and reverse
- Hands free, stress free
- Long range on board igniting capability

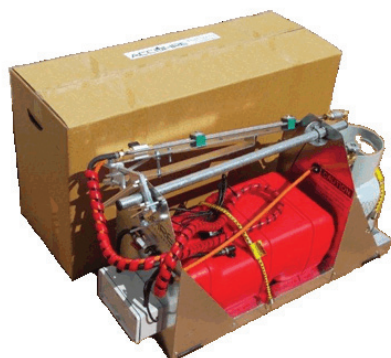

## SPARE PARTS

PRODUCT	DESCRIPTION
FUEL TANK	A boat fuel tank stores the liquid accelerant used for the combustable fuel source.
GAS BOTTLE	A propane filled gas bottle is used as the storage vessel for the firelighters ignition fuel.
PUMP	An electrical pump and solenoid assembly is used to apply the flow and stop mechanism to the liquid accelerant.
CHASSIS	The chassis of the firelighter houses the key components of the firelighter.
SWINGARM AND CLAMP	The swingarm is the mounting apparatus for 2 stainless steel lances and directs the pipes approximately 30 to 40cm off the ground. The first pipe carries the liquid accelerant, the second carries the propane gas. The Clamp mounts the swingarm to the side of the utility vehicle.

\$2,100

PRICES EXCLUDE GST

T: (08) 9362 6811

71

F: (08) 9361 3263

# HOUSEHOLD PUMPS

## Torrium2 Controlled Systems



### Davey XP with Torrium2

- Robust and compact
- Single stage jet assisted pump
- Suitable for use on small to average sized single storey homes

MODEL NO	kW (P <sub>2</sub> )	INLET/ OUTLET	MAXIMUM FLOW	MAXIMUM PRESSURE	TORRIUM2
XP45T	0.45	1"(F) / 1"(M)	45LPM	320k PA	TT45



### Davey HP with Torrium2

- Robust and compact
- Whisper quiet operation
- Strong even pressure for medium to large single or multistorey homes

MODEL NO	kW (P <sub>2</sub> )	INLET/ OUTLET	MAXIMUM FLOW	MAXIMUM PRESSURE	TORRIUM2
HP45-05T	0.55	1¼"(F) / 1"(M)	70LPM	330 kPA	TT45
HP-65-06T	0.60	1¼"(F) / 1"(M)	100LPM	330 kPA	TT45
HP85-08T	0.80	1¼"(F) / 1"(M)	140LPM	330 kPA	TT45



### Davey HS with Torrium2

- Low power consumption, quiet and compact
- Four stage centrifugal pump for high pressure domestic applications
- Ideal for medium to large size single and multistorey homes

MODEL NO	kW (P <sub>2</sub> )	INLET/ OUTLET	MAXIMUM FLOW	MAXIMUM PRESSURE	TORRIUM2
HS50-06T	0.60	1¼"(F) / 1"(M)	80LPM	470 kPA	TT70
HS60-08T	0.76	1¼"(F) / 1"(M)	110LPM	490 kPA	TT70



### Davey XJ with Torrium2

- Robust and compact, single stage jet assisted pump
- Designed for medium to large size, single and multistorey homes
- Suitable for use on a variety of water qualities

MODEL NO	kW (P <sub>2</sub> )	INLET/ OUTLET	MAXIMUM FLOW	MAXIMUM PRESSURE	TORRIUM2
XJ50T	0.56	1"(F) / 1"(M)	50LPM	450 kPA	TT45
XJ70T	0.80	1"(F) / 1"(M)	70LPM	480 kPA	TT70
XJ90T	1.10	1¼"(F) / 1"(M)	90LPM	450 kPA	TT45

PRICES EXCLUDE GST

T: (08) 9362 6811

72

F: (08) 9361 3263

# WATER DISINFECTION

## AquashieldMAX Pressure Boosting and Treatment Packages

- Three stage treatment process for tankwater supplies with flows up to 70LPM.
- Provides pressure boosting and control, two stage pre-filtration down to 1 micron and UV disinfection in a conveniently packaged system.
- Optional fan pack recommended to assist with cooling for high temperature or non-ventilated spaces.  
Easily retrofits onto existing Aquashield systems.
- Provides 30mJ/cm<sup>2</sup> at 90% or above UV Transmission (UVT)



SELECTING A SYSTEM			
Pressure	Outlets	Single Water Source With Torrium Controller	Dual Water Source With RainBank Controller
Standard Pressure Up to 500 kPa	Up to 70LPM	ASHS60-08T	ASHS60-08RB
Premium Pressure Up to 700 kPa	Up to 70LPM	ASHM60-10T	ASHM60-10RB

MODEL NO	APPLICATION	kW (P <sub>2</sub> )	INLET/OUTLET	MAX. HEAD	PRICE
ASHS60-08T	Medium pressure with Torrium2 for single water source	0.76	1 1/4" / 1"	30m	\$4,450
ASHM60-10T	Higher pressure with Torrium2 for single water source	0.94	1 1/4" / 1"	38m	\$4,675
ASHS60-08RB	Medium pressure with RainBank for mains backup	0.76	1 1/4" / 1"	30m	\$4,450
ASHM60-10RB	Higher pressure with RainBank for mains backup	0.94	1 1/4" / 1"	38m	\$4,675

### Option

PART NO	DESCRIPTION	PRICE
32722	Optional cool touch fan pack, for high temperature environments or non ventilated spaces. Suits 50 and 70 litre per minute Aquashield systems	\$385

## Microlene's Centurion Xtra Smart 3 Stage UV System

- Filtration and disinfection of Rainwater, Bore or Surface water (subject to water quality).
- Suits small to medium home's potable water supply.
- Special filter design with O-ring groove for fail safe installation.
- High maximum operating pressure 827kPa (120psi) and single manifold heads (no potential leaks between heads).
- Xtra Smart controller with a multitude of screens displaying diagnostics, status, warnings and even QR codes for a link to replacement parts.
- 316 l stainless steel, axial flow chambers allow for optimum efficiency.
- 10 year limited warranty on UV chambers.



PRICES EXCLUDE GST

T: (08) 9362 6811

73

F: (08) 9361 3263

# WATER DISINFECTION

## Ultra Violet Water Disinfection Kits

### Applications

Davey Microlene UV water disinfection kits are a proven 3 stage treatment solution for a safe and effective means of eliminating harmful bacteria from drinking water supplies.

- Kit options utilising separate housings and UV units provide flexibility for installs where rack systems may not be suitable. Also allows for easy add-ons such as an additional single housing for utilising a carbon filter for taste and odour if required.
- Filtration and disinfection of rainwater.
- Small cottage through to large homes and small commercial applications.
- Suitable for bore and surface water – subject to water quality.

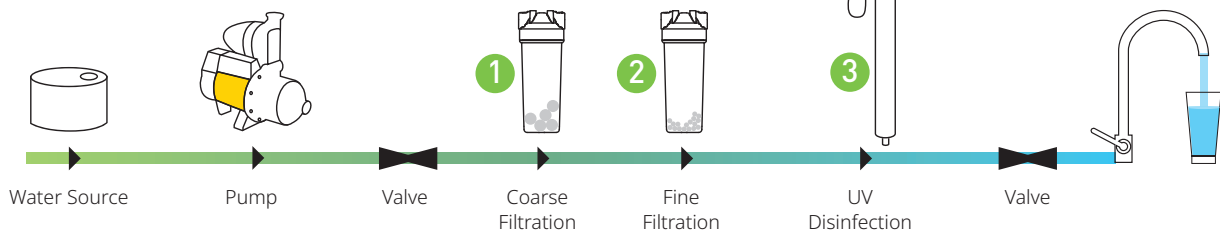

### Benefits of Microlene's UV Systems and Housing Kits

Microlene's proven three-stage Filtration and Ultraviolet disinfection kits can provide continuous clean, safe and fresh tasting water from your rainwater tank. In conjunction with pre-filtration, UV is the best practical option for treating drinking water and is widely used in disinfecting the drinking supplies of not just individual homes, but entire towns.

The KUV kits are supplied as individual components for flexibility during installs where a normal rack system may not be suitable. The UV kits consists of:

- 20 micron pre-filtration for the removal of dirt, rust, sediment and debris reduction [step 1](#)
- 1 micron depth filtration for parasitic cyst reduction and further sediment reduction to reduce 'shadowing' of pathogens [step 2](#)
- Microlene UV water disinfection kits with low pressure lamp and tube quartz sleeve for easy cleaning and high performance [step 3](#)
- Universal flow direction. Flexibility for installing in the space and direction as required.
- LED lamp count down timer and audible alarm, with set limit of 9,000 hours continuous use on UV24, UV57, UV80 (which is 12 months), and 10,000 hours continuous use on the UV151 (14 months) ensuring only disinfected water is delivered\*
- Microlene kits should be connected via PVC plumbing which is not included with the kits as every install is different.

### OPERATING LIMITS

MODEL	KUV24	KUV57A	KUV80A	KUV151A
Flow	Standard Output			High Output
16mj/cm <sup>2</sup> @95% UVT	41 lpm	110 lpm	150 lpm	295 lpm
30mj/cm <sup>2</sup> @95% UVT	23 lpm	57 lpm	79 lpm	151 lpm
40mj/cm <sup>2</sup> @95% UVT	17 lpm	45 lpm	59 lpm	120 lpm
Max System Pressure	860kPa (125psi)			
Electrical	90-265V/50-60Hz. 1A Max.			
Operating Water Temp.	0 - 40°C			
Max. Ambient Temp.	50°C			
Lamp Life (Hours)	9,000			10,000

PRICES EXCLUDE GST

# DELMHORST MOISTURE METERS

Hay growers rely on Delmhorst hay moisture meters to produce top-quality hay with optimum nutritional value and reduced risks of mold growth and spoilage. Delmhorst offers a variety of hay moisture meters to check hay in the windrow, during the baling process, and in the bale.

## F-2000

The F-2000 is great for hay producers looking to enhance quality control. The F-2000 checks hay moisture in the windrow or in bales, and comes with the same accuracy and clarity as the FX-2000!

### Product Features

- Bright, clear digital display.
- Averages up to 100 accumulated readings.
- Displays average and highest of accumulated readings.
- Moisture Range: 6%-40% on hay.
- Built-in calibration check.
- Audible, adjustable alarm alerts you when a pre-selected MC has been reached.
- Size: 8" x 3" x 1 5/8".
- Weight: 10 oz.
- Rugged construction ensures years of reliable use.
- Optional sturdy plastic carrying case.
- 9V battery.
- 3-year warranty.



**Individual Instrument: Part No: F2000**

**Deluxe 18" Package: Part No: F2000K**

Includes meter, H-4 handle, 830-3 18" probe and carrying case.

## FX-2000

This state-of-the-art meter is ideal for high-volume producers who need the time-saving convenience of on-the-go monitoring. Whether in the windrow, on-the-go while baling, or in the bale, the FX-2000 gives clear, accurate moisture readings every step of the way!

### Product Features

- Bright, clear digital display.
- Can be used for on-the-go moisture monitoring or as a portable meter.
- In continuous mode:
  - Takes two readings every second.
  - Displays the average and highest of eight accumulated readings.
  - Readings updated every 4 seconds.
  - Built-in back light.
  - Connects to tractor power supply.
- In portable mode:
  - Averages up to 100 accumulated readings.
  - Displays average and highest of accumulated readings.
- Moisture Range: 6%-40% on hay.
- Built-in calibration check.
- Audible, adjustable alarm alerts you when a pre-selected MC has been reached.
- Size: 8" x 3" x 1 5/8".
- Weight: 10 oz.
- Rugged construction ensures years of reliable use.
- Optional sturdy plastic carrying case.
- 9V battery.
- 3-year warranty.



**Individual Instrument: Part No: FX2000**

**Deluxe 18" Package: Part No: FX200K**

Includes meter with power supply, 1986 bale sensor with cable and mounting bracket, H-4 handle, 830-3 18" probe, and carrying case.

PRICES EXCLUDE GST

**T: (08) 9362 6811**

**75**

**F: (08) 9361 3263**

# DELMHORST MOISTURE METERS SPARES

Delmhorst offers a wide assortment of accessories known throughout the industry for their durability. All Delmhorst electrodes fit any Delmhorst moisture meter.

## FX-2000 ELECTRODES



### 1235

10" prod used for testing standard bales. Attaches directly to the connector on top of the meter. Also available in 18" length as 1235/18.

## FX-2000 ELECTRODES



### 831 Short Pin Prod

For testing hay in the windrow (requires H-4 Handle).

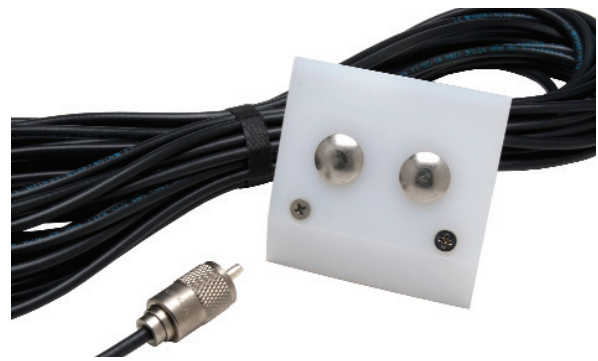

### 1986 Bale Sensor

For continuous monitoring during baling. Comes with 30' cable to run from the sensor mounted in the bale chamber to the meter in the cab. May be used with any model, but is recommended to use with Model FX-2000.

Also available as 1986/40 with 40' cable for larger balers.



### H-4 Handle

Electrode handle that attaches to the built-in connector on the top of any moisture meter. Can be used with the 830 series prods, 831 short pin disc shaped prod, and 832 long pin disc shaped prod. This is useful for large or high density bales of hay or scrap paper. Two handed operation is recommended over using a prod that connects directly to the top of the meter (like our 1235 series) to minimize stress placed on the meter casing.



### 830 Series

Prods for testing standard and high density bales (requires H-4 Handle). Available as:

830-2 - 10" prod

830-3 - 18" prod

830-4 - 36" prod

830-5 - 12" for hops



### 2110

Split bale chamber sensor for use with Freeman balers.

PRICES EXCLUDE GST

T: (08) 9362 6811

76

F: (08) 9361 3263

# DELMHORST MOISTURE METERS SPARES

Delmhorst offers a wide assortment of accessories known throughout the industry for their durability. All Delmhorst electrodes fit any Delmhorst moisture meter.

## FX-2000 ACCESSORIES

---



### 1985

The 1985 is a replacement 30ft coaxial cable for the 1986 bale chamber sensor. Also available in 36ft and 40ft lengths as 1985/36 and 1985/40 respectively.

---



### 1986/EXTENSION

Extends mounting bolts used when installing 1986 bale chamber sensor. Used for newer balers with thick chamber walls.

---



### 315ACC-0003

This kit includes the power supply cable and mounting hardware necessary to install the FX-2000 in your tractor cab.

---

## FX-2000 ACCESSORIES

---



### 324CAS-0065 Carrying Case

This carrying case may be purchased as a part of one of our deluxe moisture meter packages, and fits all prods except the 1986 bale sensor, 830-3 prod, and 830-4 prod. Can also be purchased separately.

---



### MCS-4

This moisture content standard is great for verifying that your F-series hay moisture meter is in calibration. With two electrical resistance values (16% and 22%) to test your meter against, you can be sure that your readings will stand up to the strictest standards of accuracy. The MCS-4 is also available with a letter of certification traceable to NIST.

---

PRICES EXCLUDE GST

T: (08) 9362 6811

77

F: (08) 9361 3263

# BALER TWINE

Balers are bigger and **contractors are demanding** professionals looking for **higher density bales**.

To match this challenge they need a high performance twine to **ensure High Knot Strength** and **good grip**, avoiding slippage **even in the most extreme** baling conditions.

◆ PREMIUM QUALITY

◆ HEAVY DUTY

◆ TENSION TESTED

◆ U.V. STABILISED

◆ POLYPROPYLENE



To meet this challenge CordexAgri developed ULTRA GRIP.

- 80% Higher Grip than any standard twine,
- Guaranteed Knot Strength - 250kg (550lb)
- High Anti U.V.

REFERENCE	WEIGHT	RUNNAGE	SPOOLS PER PACK	PACKS / PALLET	KNOT STRENGTH	COLOUR
ULTRAGRIP 110	20 KG	110m /Kg	2	24	250 KG/F	BLUE
EXTREME 108	20 KG	108m /Kg	2	24	260 KG/F	CREME
MAXXCORD 108	12.6 KG	180m /Kg	2	24	275 KG/F	PINK

**Today's baling is a job for experts!**



PRICES EXCLUDE GST

T: (08) 9362 6811

78

F: (08) 9361 3263



# BALER TWINE

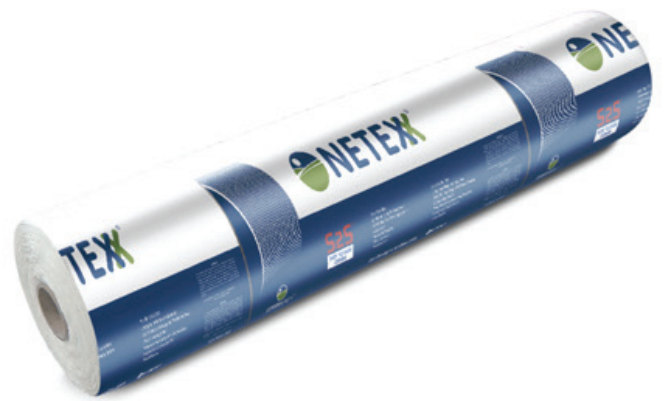

Committed to research, design and integration, Cordexagri is dedicated to providing the best performing net wrap on the market.

Netex offers farmers and contractors complete bale coverage and can be used in all makes and models of round baling machines.



NETEX	TECHNOLOGY	ROLLS PER PALLET
1.23 X 3600	S2S	28
1.30 X 3600	OS	28

S2S - Side to side  
OS - Over the side



◆ MINIMUM LENGTH GUARANTEE

◆ 50M RED END WARNING SYSTEM

◆ EASY LOAD

◆ REUSABLE HANDLES

◆ UV PROTECTION

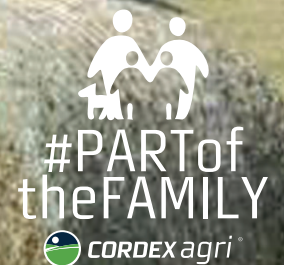

PRICES EXCLUDE GST

T: (08) 9362 6811

79

F: (08) 9361 3263

# BALER TWINE



A co-extruded 5 layer film, engineered with high puncture resistance. Its superior strength guarantees its suitability for both round and square bale wrapping in the toughest conditions.

## SILACORD STRETCH FILM

750mm x 25 micron x 1500m

40 ROLLS / PALLET

COLOURS GREEN, WHITE

Silacord has a high anti-UV content to prevent film degradation and high barrier properties to prevent spoiled fodder. Suitable for round and square wrapping machines.

# SILAGE FILM SILACORD™

› CO-EXTRUDED 5 LAYER FILM

› HIGH PUNCTURE RESISTANCE

› SUPERIOR STRENGTH

› SUITABLE FOR ROUND AND LARGE SQUARE BALE WRAPPING

› FOR TOUGH CONDITIONS

› UV PROTECTED TO PREVENT FILM DEGRADATION

› HIGH BARRIER PROPERTIES TO PREVENT SPOILED FODDER



PRICES EXCLUDE GST

T: (08) 9362 6811

80

F: (08) 9361 3263

# GRAIN STORAGE - GRAINFLEX

## Tougher - Safer- More Flexible.

Latest technology seven layer grain tubes made from a combination of remarkable new polymers, Grain-Flex® Tubes are suitable for all human and animal grain applications, and performs well within modern high capacity grain bag extractors. You can fill these 100% recyclable bags in the field, so they will save you time, labour, storage and fuel costs.

- 7 Layer technology.
- Developed to fit 2.75m (9ft) diameter grain loaders.
- Exceptional puncture & tear resistance.
- UV protected for Australian conditions.
- Easy to install.
- Manufactured to strict ISO9001 QA standards from seven-layered co-extruded polythene film using only high quality performance resins and additives.



CODE	PRODUCT / BRAND	COLOUR	WIDTH	LENGTH	GAUGE	ROLLS / PALLET
GFHART975	GRAIN FLEX	WHITE	2.75M (9FT)	75M	250UM	4 OR 6







PRICES EXCLUDE GST

T: (08) 9362 6811

81

F: (08) 9361 3263

# SERVICE EXCHANGE GEARBOXES

PART NO	DESCRIPTION	SUITS
SEG1010 	CASE IH MOWER GEARBOX A86518543	DCX131, DCX131F, DCX161, DC132, DC132F, DC162, DC162F
SEG1020 	CASE IH SWIVEL GEARBOX 700713871	DC162, DC132, DCX161, DC515, 8312, 8315
SEG1030 	AFH207196 Replaces John Deere OEM nos AFH204883, AFH202245	John Deere 448, 449, 458, 458F, 459, 468, 468F, 469, 558, 568
SEG1010 	NEW HOLLAND MOWER GEARBOX A86518543	H7450, H7550, H7460, H7560, 1431, 1432, 1441, 1442, 2331, 2332

\* These are replacement parts only. Not OEM. Original parts numbers are used for reference only.

# HAY FORKS

	PART NO	DESCRIPTION	SUITS
<b>STRAIGHT TINES</b>			
	B84007	820mm (32")	Conus II type M28 Fixing nut
	B84008	980mm (38 1/2")	
	B84009	1100mm (43")	
	B84010	1240mm (49")	
	B84012	1400mm (55")	Conus III type M33 x 2 Fixing nut
<b>CURVED TINE</b>			
	B84011	600mm (24")	Curved Grab Tine. Conus I Keyed Type
<b>WELD-IN MOUNTING SLEEVES</b>			
	B84101	Conus II type 57mm (2 1/4") Outside diameter	
	B84103	Conus III type 80mm (3.149") Outside diameter	
	B84102	Special Conus I type 50mm (1.968") Outside diameter	
<b>REPLACEMENT MOUNTING NUT</b>			
	B84106	Nut 28mm (1.125") thread dia fits Conus II type. Fits LATE TYPE BLUE LINE spikes	
	B84014	Nut fits Conus III TYPE BLUE LINE spikes	

PRICES EXCLUDE GST

T: (08) 9362 6811

82

F: (08) 9361 3263

# SPARE PARTS

	PART NO	DESCRIPTION	APPLICATION
<b>SITREX</b>			
	AS6001	Wheel Right Hand for Sitrex type Wheel Rake	SITREX
	AS6002	Wheel LEFT Hand for Sitrex type Wheel Rake	SITREX
	AS6010	Tine for Sitrex type Wheel Rake - "A" = 27.5cm	SITREX
<b>TEAGLE</b>			
	AT6010	Yellow 7.1mm	
<b>VICON</b>			
	AA6001	Wheel - Tines Offset - Dished = 93345	ACROBAT
	AV6001	Wheel - Tines Flat = 2299060	SPRINTMASTER
	AV6001	Wheel Right Hand = 2299060	V8, V10, V12 + All Flat Wheel "V" Rakes
	AV6002	Wheel Left Hand = 2299061	
	AV6010	Tine "A" = 30cm Twisted Hook = 92611 (40 per wheel)	ACROBAT
	AV6012	Tine "A" = 25cm Flat Hook = 36133 (40 per wheel)	SPRINTMASTER + "V" Rakes
<b>WILKINSON</b>			
	AW6010	Silver 6.3mm	
	AW6012	Green 7.1mm	
	AW6020	Wilkinson Wheel Ring	

PRICES EXCLUDE GST

T: (08) 9362 6811

83

F: (08) 9361 3263

# DRAPER FRONT BELTING



ORDER NO	MODEL APPLICATION	DETAILS
<b>Agco</b>		
Side Belting	(Sold per foot)	
SBAG41	All Agco Draper Fronts	41" wide - no V guide
SBAG41A	Agco Draper Fronts 9250 Series	41" Wide - V guide on edge
SBAG41B	Agco Draper Fronts 5200 Series	41" Wide - V guide inset 100mm
Connector	(Sold as a Kit)	
BCAG41	Suits 41" side belting	Includes Bolts and Nuts
Centre Feed Belt	(Sold as a Kit to exact size with joining holes pre punched and includes a Connector Kit)	
FBAG60	Agco Draper Fronts	60" wide by 57½" long - no V guide
FBAG51	Agco Draper Fronts 9250	51.5" wide by 63" long – with V guide

## Class

SBCL395	Maxflo 1050 (35t), 1200 (40t) - Side Belting	1020mm wide with V guide
---------	--	--------------------------

## Honeybee also sold as New Holland

Side Belting	(Sold per foot)	
SBHB42	All Honeybee - New Holland to approx 2009	42" wide - no V guide
SBHB4175	Honeybee - New Holland 2009 on	41.75" wide - with V guide
SBMD416	Honeybee - 4000 Series 2015 on (Airflx)	41.6" wide - with V guide
Connector	(Sold as a Kit)	
BCHB42	Suits 41¾ " and 42" side Belting	Includes Bolts and Nuts
BCHB69	Suits 69" Centre Belt	Includes Bolts and Nuts

\* These are replacement parts only. Not OEM. Original parts numbers are used for reference only.



PRICES EXCLUDE GST

T: (08) 9362 6811

84

F: (08) 9361 3263

# DRAPER FRONT BELTING



ORDER NO	MODEL APPLICATION	DETAILS
----------	-------------------	---------

### Honeybee also sold as New Holland

Centre Feed Belts	(Sold as a Kit to exact size with joining holes pre punched and includes a Connector Kit)	
FBHB34	Honeybee - New Holland - Some early (2 required per machine)	34" wide - no V guide
FBHB68	Honeybee - New Holland 2009 on	68.75" wide by 63" long - with V guide
FBHB69	Honeybee - New Holland to approx 2009	69" wide by 65" long - no V guide
FBHB4175	Honeybee - New Holland 2009 on (2 required per machine)	41.75" wide - with V guide
FBHB7975	Honeybee - New Holland 2009 on (2 required per machine) inc 4000 series	FBHB4175

### John Deere

Side Belting	(Sold per foot)	
SBJD36	930D, 936D Draper Fronts	36" wide - with V guide
SBJD395	630D, 635D, 640D Draper Fronts	39.5" wide - with V guide
Connector	(Sold as a Kit)	
BCJD36	Suits 36" wide belting	Includes Bolts and Nuts
BCJD395	Suits 39 1/2" wide belting	Includes Bolts and Nuts
BCJD55	Suits 55.3" wide centre belt	Includes Bolts and Nuts
BCJD60	Suits 60" wide centre Belt	Includes Bolts and Nuts
Centre Feed Belts	(Sold as a Kit to exact size with joining holes pre punched and includes a Connector Kit)	
FBJD60	930D, 936D Draper Fronts	60" wide by 63 1/2" long - with V guide
FBJD553	630D, 635D, 640D Draper Fronts	55.3" wide by 58" long - with V guide

\* These are replacement parts only. Not OEM. Original parts numbers are used for reference only.

PRICES EXCLUDE GST

T: (08) 9362 6811

85

F: (08) 9361 3263

# DRAPER FRONT BELTING



ORDER NO.	MODEL APPLICATION	DETAILS
<b>Midwest</b>		
Side Belting	(Sold per foot)	
SBMW36	All Midwest Draper Fronts	36" wide - with centre V guide
Connector	(Sold as a Kit)	
BCJD36	All 36" wide belting	Includes Bolts and Nuts
BCJD60	Suits 60" wide centre belt	Includes Bolts and Nuts
Centre Feed Belts	(Sold as a Kit to exact size with joining holes pre punched and includes a Connector Kit)	
FBMW44	Suit Midwest with narrow body centre design	44" wide – with V guide
FBMW60	Suit Midwest with wide body centre design	60" wide – with V guide
<b>Case/New Holland</b>		
Centre Feed Belt		
FBCNH42	Suits NH800 Series CIH31 Series (OEM 84289411)	42" wide
SBMD416	840C 880CF and Case-IH 3152 3162	41.6" wide - with V guide
<b>Macdon also sold as Case-IH and New Holland</b>		
Side Belting	(Sold per foot)	
SBMD416	All Macdon prior D60 and Case-IH prior to 2152, 2162	41.6" wide - with V guide
SBMD416DG	D60, D65, FD75 Macdon series 2152, 2162 Case-IH, 83C New Holland	41.6" wide - with double V guide
SBMD415	Early Case-IH swather, Agware swather	41.5" wide - no V guide
SBHB42	Case-IH swathers – 8120 on, some Hesston and Versatile	42" wide - no V guide
Connector	(Sold as a Kit)	
BCMD416	Suits 41 1/2", 41.6" side belting	Includes Bolts and Nuts
BCHB42	Suits 42" side belting	Includes Bolts and Nuts
Centre Feed Belts	(Sold as a Kit to exact size with joining holes pre punched and includes a Connector Kit)	
FBMD374	Macdon, Case-IH	37.4" wide by 85¾" long - with V guide
FBMD384	Macdon, Case-IH	38.4" wide by 97" long - with V guide
FBMD415	Macdon, Case-IH	41.5" wide by 85¾" long - with V guide
FBMD454	Macdon, Case-IH	45.4" wide by 97" long - with V guide
FBMD549	Macdon, Case-IH	54.9" wide by 85¾" long - with V guide
FBMD559	Macdon, Case-IH	55.9" wide by 97" long - with V guide
FBMD595	Macdon, Case-IH	59.5" wide by 85¾" long - with V guide
FBMDDG-IV	Macdon, Case-IH, 83C New Holland	78.5" wide by 63¾" long - with single V guide

\* These are replacement parts only. Not OEM. Original parts numbers are used for reference only.

PRICES EXCLUDE GST

T: (08) 9362 6811

86

F: (08) 9361 3263



# DRAPER FRONT ROLLERS



## Polyurethane Sleeves for Drive Rollers

For excellent grip on driving rollers.

Honeybee		John Deere	
	<b>HBDR05 Side Belt Driving Roller (inc. bearing)</b> Honeybee & New Holland Suits 42" Belting - No Vee Guide		<b>HMOMS10 OMS100 Hydraulic Motor</b> 1 1/4" shaft - suits Knife Drive
	<b>HBDR05L Polyurethane Sleeve Kit</b> Suits HBDR05 roller 2 1/2"		<b>HMOMP100 OMP40 Hydraulic Motor</b> 1" shaft - suits Knife Drive
	<b>HBIR10 Side Belt Idler Roller (inc. 2 bearings)</b> Honeybee & New Holland Suits 42" Belting - No Vee Guide		<b>HBDRCB1 Bearing (1 Req'd)</b> Suits HBDRCB1 Original Part: 86560881
	<b>HBDR15 Side Belt Driving Roller (inc. bearing)</b> Honeybee and New Holland Suits 41.75" Belting with Vee Guide		<b>HBDRCS1 Seal (1 Req'd)</b> Suits HBDRCB1
	<b>HBDR15L Polyurethane Sleeve Kit</b> Suits HBDR15 roller 2 1/2"		<b>HBIRCB1 Bearing (4 Req'd)</b> Suits HBIRCB1
	<b>HBIR20 Side Belt Idler Roller (inc. 2 bearings)</b> Honeybee and New Holland Suits 41.75" Belting with Vee Guide		<b>HIRCS1 Seal (2 Req'd)</b> Suits HBIRCB1
	<b>HBDR69 Centre Drive Roller (inc. bearing and seal)</b> Suits Honeybee & New Holland with 69" Feed Belt no Vee Guide and 68 3/4" Feed Belt with Vee Guide		<b>HBHB Hexagonal Bearing</b> Suits all Honeybee Rollers
	<b>HBDR69L Polyurethane Sleeve Kit</b> Suits HBDR69		<b>HBHM40 OMP40 Hydraulic Motor</b> Suits Honeybee & New Holland Belt Fronts
	<b>HBIRC69 Centre Idler Roller (inc. 2 bearings and seals)</b> Suits Honeybee & New Holland with 69" Feed Belt no Vee Guide and 68 3/4" Feed Belt with Vee Guide		<b>HBHM50 OMP50 Hydraulic Motor</b> Suits Honeybee & New Holland Belt Fronts
	<b>HPJD-9155 Hydraulic Motor - Draper Drive</b> Suits 925D 930D 936D Bile and Centre Feed Drives Original Part: AH159155 <b>NEW</b>		<b>JDIRC900 Centre Idler Roller (inc. 2 bearings)</b> Suits JD 930 936 Draper Front Original Part: H213228
	<b>JDDR36 Side Belt Driving Roller (inc. Bearing)</b> Suits 930 936 Draper Front Original Part: AH212964		<b>JDDR40 Side Belt Driving Roller (inc. bearing)</b> Suits 635 640 645 Draper Front Original Part: AXE16282
	<b>JDDR36L Polyurethane Sleeves</b> Suits JDDR36		<b>JDDR40L Polyurethane Sleeves</b> Suits JDDR40
	<b>JDIR36 Side Belt Idler Roller (inc. 2 bearings)</b> Suits 930 936 Draper Front Original Part: H213230 H160572		<b>JDDIR40 Side Belt Idler Roller (inc. 2 bearings)</b> Suits 635 640 645 Draper Front Original Part: H216011
	<b>JDDRC900 Centre Drive Roller (inc. bearing)</b> Suits JD 930 936 Draper Front Original Part: AH212965		<b>JDHB1 Bearing</b> Suits JDDR36 JDDRC900 JDDR40 Original Part: JD9338
	<b>JDDRC900L Polyurethane Sleeves</b> Suits JDDRC900		<b>JDHB2 Hexagonal Bearing</b> Suits JDIR36 JDIR40 JDIRC900 Original Part: AXE10322 AXE50068

PRICES EXCLUDE GST

T: (08) 9362 6811

87













F: (08) 9361 3263

# DRAPER FRONT ROLLERS







## Macdon

	<b>MDDR-3962 Side Belt Driving Roller (inc. Bearing)</b> Suits Macdon 960 962 Case-IH 1040 1042 2042 2 1/4" Original Part: MD 113962 C-IH 338721A1 395816A1
	<b>MDIR-3320 Side Belt Idler Roller &amp; Axle (inc. 2 Bearings)</b> Suits Macdon 960 962 Case-IH 1040 1042 2042 2 1/4" Original Part Roller: MD 43820 C-IH 131499A1 Original Part Shaft: MD 49056 C-IH 338342A1
	<b>MDDR-3837 Side Belt Driving Roller (inc. Bearing)</b> Suits Macdon 972 973 Case-IH 1052 2052 2 1/4" Original Part: MD 113837 C-IH 395815A1
	<b>MDIR-0081 Side Belt Idler Roller &amp; Axle (inc. 2 Bearings)</b> Suits Macdon 972 973 Case-IH 1052 2052 2 1/4" Original Part Roller: MD 100195 C-IH 346009A1 Original Part Shaft: MD 100082 C-IH 346008A1
	<b>MDDR-4696 Side Belt Driving Roller (inc. Bearing)</b> Suits Macdon D60 D65 Case-IH 2152 2162 2 1/4" Original Part: MD 174694 C-IH & NH 84238688 MD220105
	<b>MDIR-4714 Side Belt Idler Roller (inc. Bearing)</b> Suits Macdon D60 D65 Case-IH 2152 2162 Original Part: MD 17417 C-IH & NH 84238689
	<b>MDLAG Lagging Kit for one Side Roller – Rubber</b> Used on Drive Rollers of 2 1/4" Diameter Original Part: MD 43779
	<b>MDDRC-0817 Centre Drive Roller (inc. bearing)</b> Suits Macdon 960 963 C-IH 1040 1042 2042 Suits 37.4" wide Feed Belt 2 1/2" Original Part: MD 40817 C-IH 450915A1
	<b>MDDRC-0817L Polyurethane Sleeve Kit</b> Suits MDDRC-0817 roller 2 1/2"
	<b>MDIRC-0812 Centre Idler Roller &amp; Axle (inc. 2 bearings)</b> Suits Macdon 960-962 C-IH 1040 1042 2042 Suits 37.4" wide Feed Belt 2 1/4" Original Part Roller: MD 40812 C-IH 338326A1 Original Part Shaft: MD 40810 C-IH 338364A1
	<b>MDDRC-0057 Centre Drive Roller (inc. bearing)</b> Suits Macdon 960-962 C-IH 1040 1042 2042 Suits 38.4" wide Feed Belt 3" Original Part: MD 100057 C-IH 450914A1
	<b>MDDRC-0057L Polyurethane Sleeve Kit</b> Suits MDDR-0057 roller 3"
	<b>MDIRC-0201 Centre Idler Roller &amp; Axle (inc. 2 bearings)</b> Suits Macdon 960-962 C-IH 1040 1042 2042 Suits 38.4" wide Feed Belt 2 1/4" Original Part Roller: MD 100201 MD 101715 Original Part Shaft: C-IH 338326A1 338364A1

	<b>MDDRC-3408 Centre Drive Roller (inc. bearing)</b> Suits Macdon 972 C-IH 1052 2052 Suits 45.4" wide Feed Belt 3" Original Part: MD 123408 C-IH 450915A1
	<b>MDDRC-3408L Polyurethane Sleeve Kit</b> Suits MDDR-3408 roller 3"
	<b>MDIRC-6079 Centre Idler Roller &amp; Axle (inc. 2 bearings)</b> Suits Macdon 972 C-IH 1052 2052 Suits 45.4" wide Feed Belt 2 1/4" Original Part Roller: MD 116079 MD 116080 Original Part Shaft: C-IH 430277A1 430278A1
	<b>MDDRC-7814 Centre Drive Roller (inc. bearing)</b> Suits Macdon 960 C-IH 1040 Suits 55.9" wide Feed Belt 3" Original Part: MD 87407814
	<b>MDDRC-7814L Polyurethane Sleeve Kit</b> Suits MDDR-7814 roller 3"
	<b>MDIRC-7805 Centre Idler Roller &amp; Axle (inc. 2 bearings)</b> Suits Macdon 960 C-IH 1040 Suits 55.9" wide Feed Belt 2 1/4" Original Part: 87407805 87407809
	<b>MDDRC-3891 Centre Drive Roller (inc. bearing)</b> with Splined Drive End Suits Macdon D60 D65 C-IH 2152 2162 Suits 78.5" wide Feed Belt 3" Original Part: MD 133891 C-IH 87627760
	<b>MDDRC-3891L Polyurethane Sleeve Kit</b> Suits MDDR-3891 roller 3"
	<b>MDIRC-6286 Centre Idler Axle (inc. 2 bearings)</b> Suits Macdon D60 D65 C-IH 2052 2062 Suits 78.5" wide Feed Belt Original Part: MD 156286 C-IH 47731155
	<b>MD6204B Bearing</b> Suits MDDR3962
	<b>MD6205B Bearing</b> Suits MDDR3837 MDDR4696 MDIR0081 MDIR3320 MDIR4714 MDIR0812 MDIR0201 MDIR6079 MDIR7805
	<b>MDNA206B Bearing</b> Suits MDDR0817 MDDRC0057 MDDRC3408 MDDR7814 MDDRC3891

## New Holland

	<b>MDDR-4696 Side Belt Driving Roller (inc. Bearing)</b> Suits NewHolland 82C 83C 2 1/4" Original Part: MD 174694 C-IH & NH 84238688 MD220105
	<b>MDIR-4714 Side Belt Idler Roller (inc. Bearing)</b> Suits NewHolland 82C 83C Original Part: MD 17417 C-IH & NH 84238689
	<b>MDDRC-3891 Centre Drive Roller (inc. Bearing)</b> With Splined Drive End Suits NewHolland 82C 83C Original Part: 87627766

	<b>MDDRC-3891L Polyurethane Sleeve Kit</b> With Splined Drive End Suits MDDR-3891 roller 3"
	<b>MDIRC-6286 Centre Idler Axle (inc. 2 bearings)</b> Suits NewHolland 82C 83C Suits 78.5" wide Feed Belt Original Part: MD 156286 C-IH 47731155

PRICES EXCLUDE GST

T: (08) 9362 6811

88

F: (08) 9361 3263

# PICKUP BELTS



Case-IH	
<b>PBCIHBO</b>  <p>(Teeth not inc.)</p>	<b>Belt</b> Suits 1015 403 503 21¾" wide 60⅞" long - (No Teeth Fitted) 60 Teeth per Belt required
<b>PBSMFB</b>  <p>(Teeth not inc.)</p>	<b>Front belt</b> Suits 2015 model, 18¾" wide 57¾" long (No Teeth Fitted) 42 Teeth per Belt required
<b>PBSMRB</b> 	<b>Rear belt</b> Suits 2015 model, 18¾" wide 57¾" long
John Deere	
<b>PBJDBO</b>  <p>(Teeth not inc.)</p>	<b>Belt</b> Suits 110 132 212 214 912 914 3 Roller Models 22" wide 66½" long (No Teeth Fitted) 60 Teeth/Belt
<b>PBJDBO5</b>  <p>(Teeth not inc.)</p>	<b>Belt 44½" wide x 57¼" long</b> Suits JD615P (No Teeth Fitted) 92 Teeth/Belt
Phillips Swathmaster	
<b>PBSMFB</b>  <p>(Teeth not inc.)</p>	<b>Front belt</b> 18¾" wide 57¾" long (No Teeth Fitted) 42 Teeth per Belt required
<b>PBSMRB</b> 	<b>Rear belt</b> 18¾" wide 57¾" long
<b>PBSMJNR</b> 	<b>Flat Joiner Strip incl Bolts and Nuts</b> Suits above 2 belts
<b>PBSMFBW</b>  <p>(Teeth not inc.)</p>	<b>Front belt</b> Suits late model "Rollerdown" 37¾" wide 57¾" long (No teeth fitted) 84 Teeth per Belt required
<b>PBSMRBW</b> 	<b>Rear belt</b> Suits late model "Rollerdown" 37¾" wide 57¾" long

New Holland	
<b>PBNHBO</b>  <p>(Teeth not inc.)</p>	<b>Front Belt 1515mm wide</b> Suits NH790CP 84 Teeth per Belt required Original Part: 1012062
<b>PBNHRB</b> 	<b>Rear Belt 1515mm wide</b> Suits NH790CP Original Part: 1012063
Victory	
<b>PBVICFB1</b>  <p>(Teeth not inc.)</p>	<b>Front Belt 17½" wide x 44¼" long</b> (No Teeth Fitted) 60 Teeth per Belt required Original Part: 01290-110001
<b>PBVICRB1</b> 	<b>Rear Belt 17½" wide x 44¼" long</b> Original Part: 01300-110002
<b>PBVICFB2</b>  <p>(Teeth not inc.)</p>	<b>Front Belt 17½" wide x 53½" long</b> (No Teeth Fitted) 78 Teeth per Belt required Original Part: 720010
<b>PBVICRB2</b> 	<b>Rear Belt – Plain Belt 17½" wide x 53½" long</b> Original Part: 013005-110003
Teeth	
<b>PBTEETH-SP</b> 	<b>Single Prong Teeth Victory</b>
<b>PBTEETH-DP</b> 	<b>Double Prong Teeth</b> Suits Case-IH, John Deere, Smales, Swath Master, Allis
<b>PBBN</b> 	<b>Bolt and Nut</b> Suits double prong teeth ¾" (No fangs)
<b>PBSPBN</b> 	<b>Bolt and Nut</b> Suits single prong teeth 1" (No fangs)
<b>PBJB</b> 	<b>Bolt and Nut</b> to join ends of Pick Up Belts ¾" (With fangs)

\* These are replacement parts only. Not OEM. Original parts numbers are used for reference only.



PRICES EXCLUDE GST



T: (08) 9362 6811



89

F: (08) 9361 3263

# SPARE PARTS





## DE ENGINEERS

ITEM CODE	DESCRIPTION	PRICE
AD8010	45 degree gearbox	
		
AD8020	Uni joint	
		
AD8011	Input/output pinion gear shaft 14 tooth	
		

ITEM CODE	DESCRIPTION	PRICE
AD8012	Input/output pinion gear shaft 14 tooth	
		
AD8013	Input/output pinion gear shaft 20 tooth	
		

## MOYLAN

ITEM CODE	DESCRIPTION	PRICE
E4001665000000	Double universal joint	
		
E6001655000000	Double universal joint	
		
T6010NC12000	PTO shaft 11 inch	
		
T800960NC12000	PTO shaft 15 inch	
		

ITEM CODE	DESCRIPTION	PRICE
AM8010	Bearing housing	
		
AM8011	40mm Bearing adaptor sleeve	
		
AM8012	35mm shaft	
		
DG59035SF	Simol trailer jack	
		

PRICES EXCLUDE GST

T: (08) 9362 6811

90

F: (08) 9361 3263

# TIPPER TRAILER KITS



## BRONZE

<p><b>TKBRONZESHORT</b> YBZ5-E2.5D1W2/WUCAERCA</p> <p>4TG-E90*800QZ</p> <p>THKSG2.0M</p>	<p><b>Short Bronze Kit</b> HPU 12V 2.5cc 10L SSH SLV RCA 12V Standard 1.5kW Motor 2.5cc Pump 10L Steel Square Horizontal Reservoir Solenoid Lowering Valve 3m Pendant Break Away</p> <p>Cylinder Telescopic UB C Ball 2B 4ST 110D 800STR 4 Stage 800mm Stroke</p> <p>Tipper Hose Kit Bronze 2M 2 x Nipple 3/8" BSPPM x 9/16" JICM Elbow Swivel 90° BSPPM x JICM 1/2" x 9/16" Hose Assembly 2m x 3/8" c/w Hose Ends 9/16" JICF</p>	<p>\$1,575.00</p>
<p><b>TKBRONZELONG</b> YBZ5-E2.5D1W2/WUCAERCA 6TG-E105*1000QZ</p> <p>THKSG2.0M</p>	<p><b>Long Bronze Kit</b> HPU 12V 2.5cc 10L SSH SLV RCA Cylinder Telescopic UB C Ball 2B 6ST 125D 1000STR 6 Stage 1000mm Stroke</p> <p>Tipper Hose Kit Bronze 2M</p>	<p>\$1,850.00</p>
<p><b>TKBRONZEXLONG</b> YBZ5-E2.5D1W2/WUCAERCA 6TG-E120*1250QZ</p> <p>THKSG2.5M</p>	<p><b>Extra Long Bronze Kit</b> HPU 12V 2.5cc 10L SSH SLV RCA Cylinder Telescopic UB C Ball 2B 6ST 145D 1250STR 6 Stage 1250mm Stroke</p> <p>Tipper Hose Kit Bronze 2.5M Hose Assembly 2.5m x 3/8" c/w Hose Ends 9/16" JICF</p>	<p>\$2,075.00</p>

PRICES EXCLUDE GST

T: (08) 9362 6811

91

F: (08) 9361 3263

# HYDRAULIC MOTORS

## APPLICATION

- Conveyors
- Feeding mechanism of robots and manipulators
- Metal working machines
- Textile machines
- Agriculture machines
- Food industries
- Grass cutting machinery etc.

## OPTIONS

- Model- Spool valve, gerotor
- Flange and wheel mount
- Motor with needle bearing
- Side and rear ports
- Shafts- straight, splined and tapered
- Shaft seal for high and low pressure
- Metric and BSPP ports
- Speed sensing
- Other special features

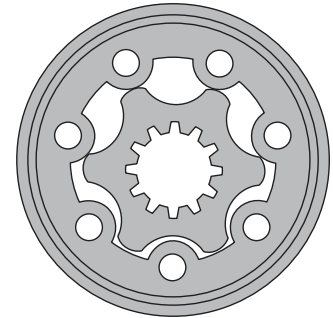

STANDARD: SHAFT 1" STRAIGHT KEYED, MOUNT SAE A 2 BOLT, PORTS 1/2" BSPP CASE 1/4" BSPP

PART NO	CC/REV	ROTOR WIDTH L1-mm	SPEED MAX CONT RPM	FLOW MAX CONT LPM	PRESSURE DROP MAX CONT BAR	INLET PRESSURE MAX CONT BAR	TORQUE MAX CONT Nm	WEIGHT KG
MP 25 COD	25	5.2	1600	40	100	175	33	6.1
MP 32 COD	32	6.3	1560	50	100	175	43	6.1
MP 40 COD	40	7.4	1500	60	120	175	62	6.2
MP 50 COD	49.5	6.67	1210	60	140	175	94	6.3
MP 60 COD	59.5	8.25	983	60	140	175	110	6.3
MP 80 COD	79.2	10.67	755	60	140	175	151	6.4
MP 100 COD	99	13.33	605	60	140	175	193	6.6
MP 125 COD	123.8	16.67	486	60	140	175	237	6.7
MP 160 COD	158.4	21.33	378	60	140	175	313	6.9



PART NO	DESCRIPTION	SUITS	ORIGINAL PART NO
HM1010	MCDON SIDE BELT DRIVE	D60 MCDON	
HM1020	SIDE BELT MCDON	MCDON 1040	CHARLYN 1012088-009
HM1030	SIDE BELT JOHN DEERE	JD 936	JOHN DEERE AH159156
HM1040	CASE 2388 RADIATOR RORARY SCREEN DRIVE	CASE 2388	EATON 1012572009

\* These are replacement parts only. Not OEM. Original parts numbers are used for reference only.

PRICES EXCLUDE GST

T: (08) 9362 6811

92

F: (08) 9361 3263

# HYDRAULIC COUPLER / MOTORS

ORDER NO	SHAFT DIAMETER	MOTOR DIS-PLACEMENT	INPUT FLOW	INPUT PRESSURE	MOTOR SPEED	TORQUE
----------	----------------	---------------------	------------	----------------	-------------	--------

## HYDRAULIC MOTOR

AGHM100C	1 3/8" 6 SPLINE SHAFT STANDARD AGRICULTURAL ASAE SPLINE	100CC 6.2CU IN/REV MAX SPEED 748RPM CONTINUOUS INTERMITTENT 900 RPM	30 LPM	1000 PSI 70 BAR	289 RPM	94 Nm			
				2000 PSI 140 BAR	274 RPM	198 Nm			
				2500 PSI 175 BAR	269 RPM	250 Nm			
			AGHM160C	1 3/8" 6 SPLINE SHAFT STANDARD AGRICULTURAL ASAE SPLINE	160CC 9.6CU IN/REV MAX SPEED 470RPM CONTINUOUS INTERMITTENT 560 RPM	30 LPM	1000 PSI 70 BAR	182 RPM	150 Nm
							2000 PSI 140 BAR	168 RPM	321 Nm
							2500 PSI 175 BAR	164 RPM	380 Nm
AGHM200C	1 3/8" 6 SPLINE SHAFT STANDARD AGRICULTURAL ASAE SPLINE	200CC 12.2CU IN/REV MAX SPEED 375RPM CONTINUOUS INTERMITTENT 450 RPM				30 LPM	1000 PSI 70 BAR	146 RPM	190 Nm
							2000 PSI 140 BAR	140 RPM	399 Nm
							2500 PSI 175 BAR	140 RPM	399 Nm
			AGHM200C	1 3/8" 6 SPLINE SHAFT STANDARD AGRICULTURAL ASAE SPLINE	200CC 12.2CU IN/REV MAX SPEED 375RPM CONTINUOUS INTERMITTENT 450 RPM	50 LPM	1000 PSI 70 BAR	245 RPM	184 Nm
							2000 PSI 140 BAR	240 RPM	395 Nm
							2500 PSI 175 BAR	240 RPM	395 Nm
AGHM200C	1 3/8" 6 SPLINE SHAFT STANDARD AGRICULTURAL ASAE SPLINE	200CC 12.2CU IN/REV MAX SPEED 375RPM CONTINUOUS INTERMITTENT 450 RPM				75 LPM	1000 PSI 70 BAR	369 RPM	160 Nm
							2000 PSI 140 BAR	362 RPM	375 Nm
							2500 PSI 175 BAR	362 RPM	375 Nm



Hydraulic motors used in the agricultural market for driving field bins and other forms of machinery requiring a 6 spline 1 3/8" PTO output shaft.

### Features:

- Roller gear stator
- Output shaft supported by tapered roller bearings
- High pressure motor seals
- Case drain not required
- Cross port relief for pressure spikes

These motors are suitable for continuous operation under rough operating conditions such as high operating pressures, thin oil, or frequent reverse cycling.

## COUPLINGS

ORDER NO	DESCRIPTION	FEMALE	MALE	LENGTH	IMAGE
<b>BREAKAWAY COUPLINGS</b>					
B256		1 3/8" 21 spline	1 3/8" 6 spline	6 1/2" 165mm	
B152	Clamp type	1 3/8" 21 spline	1 3/8" 6 spline	6 1/2" 165mm	
B259	Quick release type				
B2416	Quick release type	1 3/8" 6 spline	1 3/8" 21 spline	6 1/2" 165mm	
B153	Clamp type				
B2459		1 3/4" 20 spline	1 3/8" 6 spline	7" 180mm	
B2460		1 3/4" 20 spline	1 3/8" 21 spline	7" 180mm	
B3725		1 3/4" 6 spline	1 3/8" 6 spline	7" 180mm	
B3726		1 3/8" 6 spline	1 3/4" 20 spline	7" 180mm	

PRICES EXCLUDE GST

T: (08) 9362 6811

93

F: (08) 9361 3263

# HYDRAULIC CYLINDERS

BORE DIAMETER	1.50" 38.10mm	2.00" 50.80mm	2.50" 63.50mm	3.00" 76.20mm	3.50" 88.90mm	4.00" 101.60mm
---------------	------------------	------------------	------------------	------------------	------------------	-------------------

## TECHNICAL SPECIFICATIONS

A +0.15mm +0.20mm	0.75" 19.05	1.00" 25.40	1.00" 25.40	1.00" 25.40	1.00" 25.40	1.00" 25.40
B	1.75" 44.45	2.10" 53.34	2.10" 53.34	2.10" 53.34	2.10" 53.34	2.10" 53.34
C	1.65" 44.91	1.97" 50.04	1.97" 50.04	1.97" 50.04	1.97" 50.04	1.97" 50.04
D	1.25" 31.75	2.00" 50.80	2.00" 50.80	2.00" 50.80	2.00" 50.80	2.00" 50.80
E ±3mm	9.5" 241.30	12.25" 311.15	12.25" 311.15	12.25" 311.15	12.25" 311.15	12.25" 311.15
F	0.875" 22.23	1.25" 31.75	1.50" 38.10	1.50" 38.10	1.75" 44.45	1.75" 44.45
G	3.50" 88.90	5.125" 130.18	5.125" 130.18	5.125" 130.18	5.125" 130.18	5.125" 130.18
H	1.25" 31.75	2.125" 53.98	2.125" 53.98	2.125" 53.98	2.125" 53.98	2.125" 53.98
I	0.46" 11.68	0.71" 18.03	0.71" 18.03	0.71" 18.03	0.71" 18.03	0.71" 18.03
J	0.85" 21.59	1.125" 28.58	1.125" 28.58	1.125" 28.58	1.125" 28.58	1.125" 28.58
K	0.84" 21.34	1.10" 27.94	1.10" 27.94	1.10" 27.94	1.10" 27.94	1.10" 27.94
L	1.875" 47.62	2.75" 69.85	2.75" 69.85	2.75" 69.85	2.75" 69.85	2.75" 69.85
M	0.48" 12.19	0.472" 11.99	0.625" 15.88	0.625" 15.88	0.787" 19.99	0.787" 19.99
N	1.875" 47.63	2.375" 60.33	2.875" 73.03	3.500" 88.90	4.000" 101.60	4.500" 114.30
O	9/16" UNO	9/16" UNO	3/4" UNO	3/4" UNO	3/4" UNO	3/4" UNO
P	4.125" 104.78	4.375" 111.12	4.375" 111.12	4.375" 111.12	4.375" 111.12	4.375" 111.12
Q	0.84" 21.34	0.950" 24.13	0.950" 24.13	0.950" 24.13	0.950" 24.13	0.950" 24.13
R Rod Thread	0.75"-16 UNF	1.25"-12 UNF	1.25"-12 UNF	1.25"-12 UNF	1.25"-12 UNF	1.25"-12 UNF
S ±3mm	10.25" 260.35	12.25" 311.15	12.25" 311.15	12.25" 311.15	12.25" 311.15	12.25" 311.15

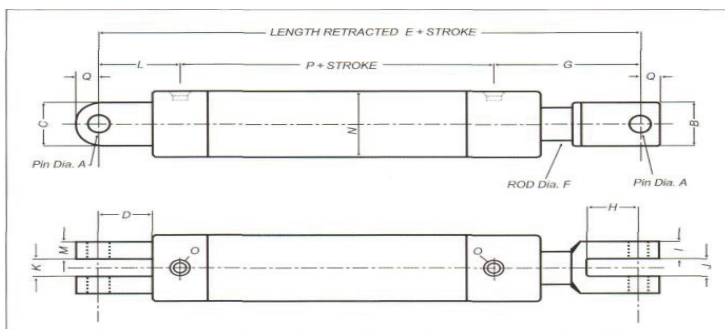

PRICES EXCLUDE GST

ORDER NO	BORE	STROKE	ORDER NO	BORE	STROKE
----------	------	--------	----------	------	--------

## HYDRAULIC CYLINDERS

1506AS	1.5"	6"	2530AS	2.5"	30"
1508AS	1.5"	8"	2536AS	2.5"	36"
1510AS	1.5"	10"	2548AS	2.5"	48"
1512AS	1.5"	12"	3008AS	3"	8"
1516AS	1.5"	16"	3010AS	3"	10"
1518AS	1.5"	18"	3012AS	3"	12"
1520AS	1.5"	20"	3016AS	3"	16"
1524AS	1.5"	24"	3018AS	3"	18"
1530AS	1.5"	30"	3020AS	3"	20"
1536AS	1.5"	36"	3024AS	3"	24"
1548AS	1.5"	48"	3030AS	3"	30"
2006AS	2"	6"	3036AS	3"	36"
2008AS	2"	8"	3048AS	3"	48"
2010AS	2"	10"	3508AS	3.5"	8"
2012AS	2"	12"	3512AS	3.5"	12"
2016AS	2"	16"	3518AS	3.5"	18"
2018AS	2"	18"	3520AS	3.5"	20"
2020AS	2"	20"	3524AS	3.5"	24"
2024AS	2"	24"	3530AS	3.5"	30"
2030AS	2"	30"	3536AS	3.5"	36"
2036AS	2"	36"	3548AS	3.5"	48"
2048AS	2"	48"	4008AS	4"	8"
2506AS	2.5"	6"	4012AS	4"	12"
2508AS	2.5"	8"	4016AS	4"	16"
2510AS	2.5"	10"	4018AS	4"	18"
2512AS	2.5"	12"	4020AS	4"	20"
2516AS	2.5"	16"	4024AS	4"	24"
2518AS	2.5"	18"	4030AS	4"	30"
2520AS	2.5"	20"	4036AS	4"	36"
2524AS	2.5"	24"	4048AS	4"	48"

ORDER NO	DESCRIPTION
----------	-------------

## HYDRAULIC HOSE

4C2AT	1/4" Double Wire Braid
6C2AT	3/8" Double Wire Braid
8C2AT	1/2" Double Wire Braid
12C2AT	3/4" Double Wire Braid
16C2AT	1" Double Wire Braid

T: (08) 9362 6811

94

F: (08) 9361 3263



# SPIRALGUARD

**SpiralGuard®** is a light weight product that is a cost effective way of protecting your hoses and cables from abrasion and impact. Because of the expanding nature of the product it is possible to wrap individual hoses as well as bundles of hoses in a loom. The product has been designed with rounded edges for ease of fitment and no sharp edges means no chance of cutting the hose.

## Key Features

- Exceptional anti-crushing and abrasion resistance
- Suitable for use in temperature ranges of -100° C to +100° C
- Easy to fit – does not cause injury
- U.V. resistant
- Suitable for single or multiple hose bundles
- Can be easily fitted on site without removal of hoses
- Self lubricating to reduce wear on hoses and cables
- Greatly extends the working life of hydraulic hoses
- Distinctive colours and clear printing of the product



## Suitability

Tested to international standards of ISO 6805. MSHA approved to MSHA IC-213/2. Flame retardant SpiralGuard™ can be utilized in a large variety of Industries.

How to calculate quantity:

$$\frac{\text{Outside diameter of hose}}{\text{Inside diameter of SpiralGuard® (mm)}} \times \text{Length (m) of hose to be covered}$$

## Example:

25m length of 40mm diameter hose, select the SpiralGuard® product based on wrapping range SGX-40

$$40 \div 33 = 1.21$$

$$1.21 \times 25 \text{ (mm)} = 30 \text{ metres of SpiralGuard® SGX-40}$$

PART NO	COLOUR	NOMINAL DIA. (inside Dia)	WRAPPING RANGE	HOSE INSIDE DIA.	1-WIRE	2-WIRE	MULTI SPIRAL	DASH SIZE	
SGX-12	BLACK	9	9-13MM	3/16"	✓	-	-	-3	
SGX-16	BLACK	13	13-17MM	1/4"	✓	-	-	-4	
SGX-20	BLACK	16	16-22MM	1/4"	-	✓	-	-4	
SGX-25B	BLACK	21	22-28MM	1/2"	✓	✓	✓	-8	
SGX-25BL	BLUE	21	22-28MM	1/2"	✓	✓	✓	-8	
SGX-25R	RED	21	22-28MM	1/2"	✓	✓	✓	-8	
SGX-25GR	GREEN	21	22-28MM	1/2"	✓	✓	✓	-8	
SGX-25Y	YELLOW	21	22-28MM	1/2"	✓	✓	✓	-8	
SGX-25W	WHITE	21	22-28MM	1/2"	✓	✓	✓	-8	
SGX-25OR	ORANGE	21	22-28MM	1/2"	✓	✓	✓	-8	
SGX-32	BLACK	27	27-33MM	5/8"	✓	✓	✓	-10	
SGX-40	BLACK	33	33-44MM	1"	✓	✓	✓	-16	
SGX-50	BLACK	44	44-65MM	1 1/4"	✓	✓	✓	-20	
SGX-75	BLACK	65	65-90MM	2"	✓	✓	✓	-32	
SGX-90	BLACK	80	HOSE LOOMS 80MM - 200MM						

PRICES EXCLUDE GST

T: (08) 9362 6811

95

F: (08) 9361 3263

# CLUTCHES

ORDER NO	DESCRIPTION	SUITS
<b>HUSKY AUGER CLUTCHES</b>		
4HD-3-1AB-SG-3/4	Clutch 3", 1 AB Section Pulley 3/4" bore	Stationary Motor Clutches
4HD-3 1/2-1A-BW-3/4	Clutch 3 1/2", 1 A Section Pulley 3/4" bore	Stationary Motor Clutches
4HD-4-1AB-BW-3/4	Clutch 4", 1 AB Section Pulley 3/4" bore	Stationary Motor Clutches
4HD-5-1A-BW-3/4	Clutch 5", 1 A Section Pulley 3/4" bore	Stationary Motor Clutches
5HD-4AB-BG-3/4	Clutch 4", 2 AB Section Pulley 3/4" bore	Stationary Motor Clutches
5HD-4-2AB-BG-1	Clutch 4", 2 AB Section Pulley 1" bore	Stationary Motor Clutches
5HD-4-2AB-BG-25	Clutch 4", 2 AB Section Pulley 25mm bore	Stationary Motor Clutches
5HD-4-2AB-BG-11/8	Clutch 4", 2 AB Section Pulley 1 1/8" bore	Stationary Motor Clutches
5HD-4 3/4-2AB-BG-30	Clutch 4 3/4", 2 AB Section Pulley 30mm bore	Stationary Motor Clutches
<b>GO KART CLUTCHES</b>		
5HD-10T-401-1	10 Tooth, 40-1 ASA Pitch 9-20HP 1" bore	Go Kart Heavy Duty
4HD-10T-401-3/4	10 Tooth, 40-1 ASA pitch 1-7HP 3/4" bore	Go Kart Heavy Duty
4HD-12T-351-3/4	12 Tooth, 35-1 ASA Pitch 1-7HP 3/4" bore	Go Kart Heavy Duty
4HD-10T-401-5/8	10 Tooth, 40-1 ASA Pitch 5/8" bore	Go Kart Heavy Duty
4HD-12T-351-5/8	12 Tooth, 35-1 ASA Pitch 5/8" bore	Go Kart Heavy Duty
MAX-10T-401-3/4	10 Tooth, 40-1 ASA Pitch, Maxtorque 3/4" bore	Go Kart Standard
MAX-12T-351-3/4	12 Tooth, 35-1 ASA Pitch, MaxTorque 3/4" bore	Go Kart Standard
MAX-10T-401-5/8	10 Tooth, 40-1 ASA Pitch, MaxTorque 5/8" bore	Go Kart Standard
MAX-12T-351-5/8	12 Tooth, 35-1 ASA Pitch, MaxTorque 5/8" bore	Go Kart Standard



5HD-4-2AB-BG-1



MAX-10T-401-5/8



4HD-10T-401-3/4

PRICES EXCLUDE GST

T: (08) 9362 6811

96

F: (08) 9361 3263



# PTO SHAFTS

COMER NUMBER	SERIES	CROSS DIMENSIONS
180.014.130	4	
180.016.130	6	
180.018.130	8	
180.019.130	9	



COMER NUMBER	SERIES	UNI-CROSS	DIMENSION CLOSED (L) MM	DIMENSION OPEN (L)	TRACTOR END	IMPLEMENT END	RATED HP @ 540 RPM
<b>COMER STANDARD PTO</b>							
T401010ENC12112	4	180.014.130	1010	1569	1 3/8 Z6 COLLAR	1 3/8 Z6 PIN	35
T401410ENC12112	4	180.014.130	1410	2242	1 3/8 Z6 COLLAR	1 3/8 Z6 PIN	35
T401910ENC12112	4	180.014.130	1910	2500	1 3/8 Z6 COLLAR	1 3/8 Z6 PIN	35
T601010ENC12112	6	180.016.130	1010	1569	1 3/8 Z6 COLLAR	1 3/8 Z6 PIN	65
T601410ENC12112	6	180.016.130	1410	2242	1 3/8 Z6 COLLAR	1 3/8 Z6 PIN	65
T601910ENC12112	6	180.016.130	1910	2500	1 3/8 Z6 COLLAR	1 3/8 Z6 PIN	65
T801010ENC12112	8	180.018.130	1010	1550	1 3/8 Z6 COLLAR	1 3/8 Z6 PIN	95
E900660NC15135	9	180.019.130	660		1 3/4 Z20 COLLAR	1 3/4 Z20 PIN	190

### COMER STANDARD PTO WITH SAFETY CLUTCH

T400760ENC12F12	4	180.014.130	760	1116	1 3/8 Z6 COLLAR	1 3/8 Z6	35
T601010ENC12F22	6	180.016.130	1010	1569	1 3/8 Z6 COLLAR	1 3/8 Z6	65
T800910ENC12F42	8	180.018.130	910	1450	1 3/8 Z6 COLLAR	1 3/8 Z6	95

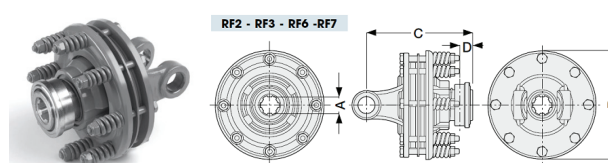
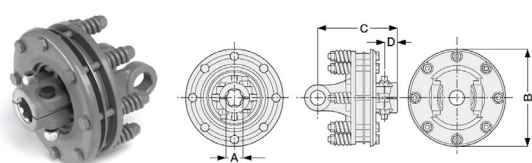

COMER NUMBER	REF	SERIES	A	B (mm)	C (mm)	D (mm)	TORQUE MAX Nm
<b>COMER SAFETY CLUTCH</b>							
146.262.001	F22	6	1 3/8 Z6	195	146	26	1200
146.264.014	F45	6	1 3/4 Z20	195	156	26	1600
146.284.011	F42	8	1 3/8 Z6	195	169	26	2000
146.284.013	F44	8	1 3/4 Z6	195	169	26	2000
<b>COMER SAFETY / OVER RUN CLUTCH</b>							
146.364.001	RF6	6	1 3/8 Z6	195	190	26	1400
146.384.003	RF8	8	1 3/4 Z6	195	203	28	1400
146.384.004	RF8	8	1 3/4 Z20	195	203	28	1400

PRICES EXCLUDE GST



# GEARBOXES

comer industries

COMER PART NO	ANDLINE PART NO	SUPPLIER	TYPE	RATIO	HP @ 540 RPM	INPUT SHAFT	OUTPUT SHAFT	OUTPUT SHAFT	WEIGHT (KG)
9.124.005.30	AL01910	COMER	L	1: 1	15	25MM	25MM	NA	4.8
9.124.020.10	AL01911	COMER	T	1: 1	15	25MM	25MM	25MM	5
9.124.006.30	AL01915		T	1.9:1	9.5	25MM	25MM	25MM	5
9.124.032.20	AL01918	COMER	T	1:1.9	15	25MM	25MM	25MM	5
9.259.007.20	AL01933	COMER	T	1:1	36	1 3/8 Z6	1 3/8 Z6	1 3/8 Z6	14
9.259.016.30	AL01938	COMER	T	1:1	36	30MM	30MM	30MM	14
9.259.032.30	AL01947	COMER	T	1:1	36	1 3/8 Z6	30MM	30MM	14
9.259.013.00	AL01934	COMER	T	2:1	17	1 3/8 Z6	1 3/8 Z6	1 3/8 Z6	14
9.259.021.00	AL01941	COMER	T	2:1	17	30MM	30MM	30MM	14
9.267.042.00	AL01953	COMER	T	1:1.46	52	1 3/8 Z6	1 3/8 Z6	1 3/8 Z6	21
9.267.023.00	AL01955	COMER	T	1:1.92	30	1 3/8 Z6	1 3/8 Z6	1 3/8 Z6	21
9.267.034.10		COMER	T	1:1.92	30	1 3/8 Z6	35MM	35MM	21
9.267.806.10	AL01952	COMER	T	1:1	55	1 3/8 Z6	1 3/8 Z6	1 3/8 Z6	21
9.267.248.00	AL01956	COMER	T	1.92:1	22	1 3/8 Z6	1 3/8 Z6	1 3/8 Z6	21
	AL01924		T	1:1	90	1 3/8 Z6	1 3/8 Z6	1 3/8 Z6	25
	AL01925		T	1:1.92	58	1 3/8 Z6	1 3/8 Z6	1 3/8 Z6	25
9.301.000.00		COMER	T	1:1	150	1 3/4 Z20	1 3/4 Z20	1 3/4 Z20	61.5
9.331.019.00		COMER	T	1:1	240	1 3/4 Z20	1 3/4 Z20	1 3/4 Z20	105
9.331.006.00		COMER	T	1:1.53	240	1 3/4 Z20	1 3/4 Z20	1 3/4 Z20	105
9.205.805.00	SLASHER	COMER	L	1:1.92	30	1 3/8 Z6	NA	NA	16
9.205.809.00	SLASHER	COMER	T	1:1.92	30	1 3/8 Z6	1 3/8 Z6	NA	16
9.140.804.20	SLASHER	COMER	L	1:1.92	60	1 3/8 Z6	NA	NA	28
9.140.872.00	SLASHER	COMER	T	1:1.92	60	1 3/8 Z6	1 3/8 Z6	NA	28
9.140.811.10	SLASHER	COMER	L	1:1.5	60	1 3/8 Z6	NA	NA	28
9.227.803.00	SLASHER	COMER	L	1:1	75	1 3/8 Z6	NA	NA	38
9.227.801.00	SLASHER	COMER	L	1:1.46	75	1 3/8 Z6	NA	NA	38
9.227.804.00	SLASHER	COMER	L	1:1.83	75	1 3/8 Z6	NA	NA	38
9.266.012.10	SLASHER	COMER	T	1:1.84	90	1 3/8 Z6	1 3/8 Z6	1 3/8 Z6	34
9.285.013.10	SLASHER	COMER	T	1:1.86	125	1 3/4 Z20	1 3/4 Z20	1 3/4 Z20	49.8
9.171.006.00	SLASHER	COMER	T	1:1	150	1 3/4 Z20	1 3/4 Z20	NA	72.5
9.171.007.00	SLASHER	COMER	T	1:1.42	120	1 3/4 Z20	1 3/4 Z20	NA	72.5
9.171.003.00	SLASHER	COMER	L	1:1.93	110	1 3/4 Z20	NA	NA	72.5



PRICES EXCLUDE GST

T: (08) 9362 6811

98

F: (08) 9361 3263

# SIMOL JACKS

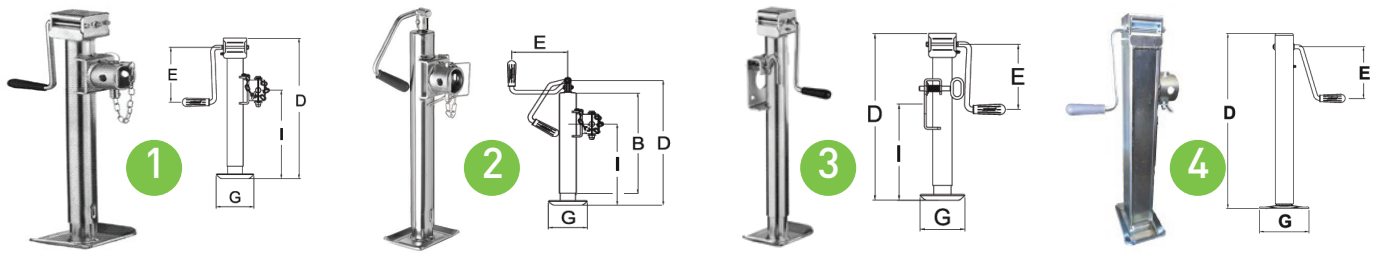

	TYPE	TUBE	SCREW STROKE mm	UNIT kg	MAX STATIC LOAD	B mm	C mm	D mm	E mm	G mm	H mm	I mm
1	LT3103	57	250	6.1	1300			430	168	120x165		280
	LT3153	57	370	7.1	1300			560	168	120x165		405
2	ST3104	57	250	5.4	1300	330		410	168	120x165		265
	ST3154	57	360	6.4	1300	455		535	168	120x165		390
	ST3254	57	360		1300	605		685	168	120x165		580
3	LF3101	57	250	6.3	1300			430	168	120x165		245
	LF3151	57	370	7.3				560	168	120x165		404
4	DG590Z	70	350	8.4	1500			530	175	120x165		

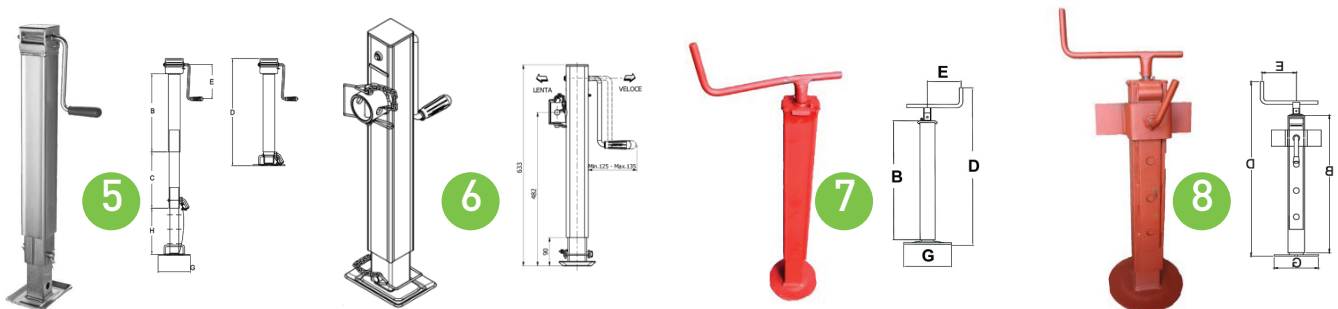

	TYPE	TUBE	SCREW STROKE mm	UNIT kg	MAX STATIC LOAD	B mm	C mm	D mm	E mm	G mm	H mm	I mm
5	DG5903SF	70	370	12.5	1500	460	370	595	170	120x165	340	
6	DG6003SFW (2 SPEED)	70	300	12.3	2000	543	300	633	209	120x165	340	482
7	P560	70	300	8.2	1000	500		670	185	160		
8	PE595	70	300	11.5	1000	500		670	185	160		

PRICES EXCLUDE GST

T: (08) 9362 6811

99

F: (08) 9361 3263

# SIMOL JACKS

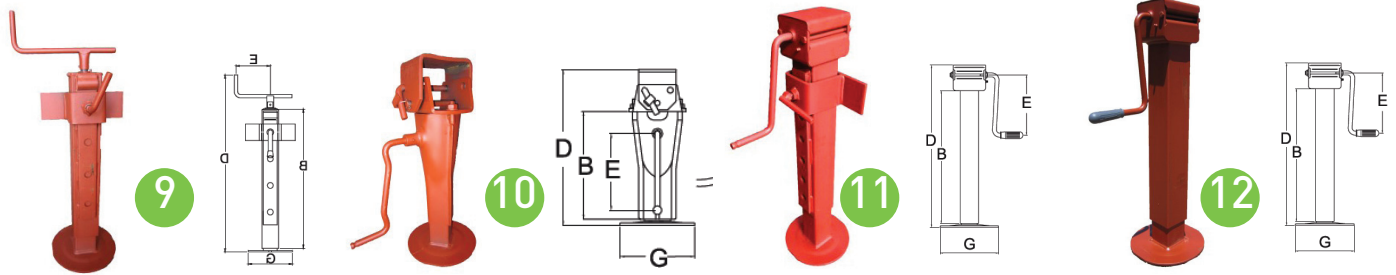

	TYPE	TUBE	SCREW STROKE mm	UNIT kg	MAX STATIC LOAD	B mm	C mm	D mm	E mm	G mm	I mm
9	PE600	80	300	16.6	1200	500		670	185	220	
10	DS510S	70	170	13.8	6000	325	125	460	220	220	415
11	DG706PE	80	300	15.6	4000	500		620	225	220	
12	DG706 DG706W (2 SPEED)	80 80	300 300	13.4 13.4	4000 4000	500 500		620 620	225 225	220 220	

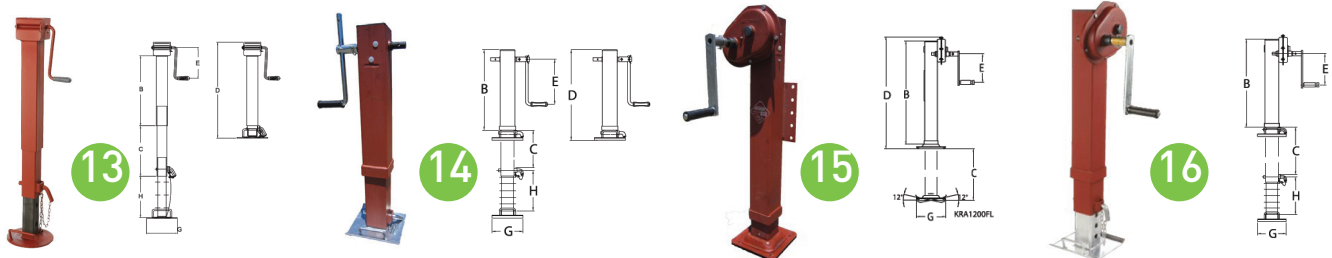

	TYPE	TUBE	SCREW STROKE mm	UNIT kg	MAX STATIC LOAD	B mm	C mm	D mm	E mm	G mm	H mm
13	DG7063SF DG7063SFW (2 SPEED)	80 80	300 300	21 21	2500 2500	500 500	290 290	685 685	225 225	220 220	276 276
14	K450	110	310	32	4500	600	310	700	325	250	300
15	KRA1200FL	110	450	45	10000	900	450	980	250	250	
16	KRA750	110	420	43.2	10000	700	420	825	250	250	300

PRICES EXCLUDE GST

T: (08) 9362 6811

100

F: (08) 9361 3263

# PRESSURE CLEANERS

ORDER NO	ENGINE	START	RATING	PUMP	FRAME	SPECIFICATIONS	WEIGHT
<b>PRESSURE CLEANERS</b>							
HB2000	HONDA	RECOIL	5 HP	HAWK PS315G 3450 RPM	FULL ROLL FRAME FOUR MINI WHEELS	11 LITRES @2000 PSI	39 KG
HB2400	HONDA	RECOIL	6.5 HP	HAWK PS315G 3450 RPM	FULL ROLL FRAME FOUR MINI WHEELS	11 LITRES @2400 PSI	41 KG
HB2500	HONDA	RECOIL	9.0 HP	HAWK PS345G 3450 RPM	FULL ROLL FRAME FOUR LARGE WHEELS	14.5 LITRES @2500 PSI	57 KG
HB3000	HONDA	RECOIL	13.0 HP	HAWK PS345G 3450 RPM	FULL ROLL FRAME FOUR MINI WHEELS	15 LITRES @3000 PSI	66 KG
HB3000R	HONDA	RECOIL	13.0 HP	HAWK HC506I REDUCTION BOX 1450 RPM	FULL ROLL FRAME FOUR LARGE WHEELS	15 LITRES @3000 PSI	75 KG
HB3000R-E	HONDA	ELECTRIC	13.0 HP	HAWK HC506I REDUCTION BOX 1450 RPM	FULL ROLL FRAME FOUR LARGE WHEELS	15 LITRES @3000 PSI	100 KG
HB6300R-E	HONDA	ELECTRIC	23.0 HP	HAWK HC650I REDUCTION BOX 1450 RPM	FULL ROLL FRAME ISOLATION MOUNTS FOUR LARGE WHEELS	20 LITRES @3000 PSI	110 KG
HB6900R-E	HONDA	ELECTRIC	27.0 HP	HAWK HC940I REDUCTION BOX 1450 RPM	FULL ROLL FRAME ISOLATION MOUNTS FOUR LARGE WHEELS	26 LITRES @3000 PSI	
HB6340R-E	HONDA	ELECTRIC	23.0 HP	HAWK HC932A REDUCTION BOX 1450 RPM	FULL ROLL FRAME ISOLATION MOUNTS FOUR LARGE WHEELS	20 LITRES @ 4000 PSI	
HB6950R-E	HONDA	ELECTRIC	27.0 HP	HAWK PX17 RE- DUCTION BOX 1450 RPM	FULL ROLL FRAME ISOLATION MOUNTS FOUR LARGE WHEELS	17 LITRES @ 5000 PSI	
HBL100R-E	YANMAR	ELECTRIC	10.0 HP DIESEL	HAWK HC506I REDUCTION BOX 1450 RPM	FULL ROLL FRAME ISOLATION MOUNTS FOUR LARGE WHEELS	15 LITRES @ 3000 PSI	

ALL UNITS ARE SUPPLIED WITH:

- 10 METRE HOSE ASSEMBLY WITH QUICK COUPLINGS
- GUN & SWIVEL
- DOUBLE STAINLESS STEEL LANCE
- DETERGENT INJECTION



HB2000



HB3000R



HB3000R-E



HB6900R-E

ORDER NO	DESCRIPTION
<b>PRESSURE CLEANERS SPARES</b>	
71001.10	10 METRE HOSE ASSEMBLY
71001.15	15 METRE HOSE ASSEMBLY
71001.20	20 METRE HOSE ASSEMBLY
H2404.11ASY	GUN, SWIVEL AND COUPLING
H2617.02ASY	DOUBLE LANCE, NOZZLE & NIPPLE
H2403.48	UNLOADER KIT VBC



HB6340R-E



HBL100R-E

PRICES EXCLUDE GST

T: (08) 9362 6811

101

F: (08) 9361 3263

# GENERATORS

ORDER NO	MAX KVA @0.8PF	CONTINUOUS OUTPUT WATTS	TANK CAPACITY	NOISE LEVEL 1/4 LOAD/7M	WEIGHT (KG)	DIMENSIONS (L x W x H)
----------	----------------	-------------------------	---------------	-------------------------	-------------	------------------------

## YAMAHA SILENT INVERTER GENERATOR

EF1000IS	1.0	900W	2.5L	47 dBA	12.7	450 x 240 x 380
EF2000IS	2.0	1600W	4.4L	51.5 dBA	20	490 x 280 x 445
EF2400IS	2.4	2000W	6.0L	54 dBA	32	527 x 419 x 459
EF3000ISE	3.0	2800W	13L	51 dBA	67	680 x 445 x 555
EF6300ISE	6.3	5500W	17L	58 dBA	91	780 x 616 x 692

## HONDA SILENT INVERTER GENERATOR

EU10i	1.0	900W	2.3L	52 dBA	13	450 x 240 x 380
EU20i	2.0	1600W	4.1L	59 dBA	21	510 x 290 x 425
EU30i	3.0	2600W	7.02L	57 dBA	35.5	622 x 378 x 490



EF1000IS



EF2000IS



EF2400IS



EF3000ISE



EU10i



EU30i

# YAMAHA ACCESSORIES

PART NO	DESCRIPTION
---------	-------------

## GENERATOR COVERS

GNCVR-10-0	COVER TO SUIT EF1000IS
GNCVR-20-0	COVER TO SUIT EF2000iS, EF2000iSC
GNCVR-24-0	COVER TO SUIT EF2400IS, EF2800I
GNCVR-30-0	COVER TO SUIT EF3000ISE

## ACCESSORIES

PARALLEL KIT	SUITS EF2400IS & EF2000IS
SECURITY CABLE	SECURITY CABLE WITH KEYS
TROLLEY	FOLDABLE TROLLEY
LUB-10W30	YAMALUBE SAE 10W30
7CF-Y2510-00	WHEEL KIT TO SUIT EF2400IS ONLY
GNRST-30	REMOTE START KIT TO SUIT EF3000ISE WORKS UP TO 10 METRES AWAY
7XF-Y8600-00	REMOTE START KIT TO SUIT EF6300ISE
7VW-Y8720-A0	REMOTE START KIT TO SUIT EF6600E AND EF7200E

PRICES EXCLUDE GST

T: (08) 9362 6811

102

F: (08) 9361 3263



# GENERATORS

ORDER NO	MAX KVA @0.8PF	CONTINUOUS OUTPUT WATTS	ENGINE TYPE	NOISE LEVEL 1/4 LOAD/7M	WEIGHT (KG)	DIMENSIONS (LxWxH)
----------	----------------	-------------------------	-------------	-------------------------	-------------	--------------------

## DUNLITE HONDA GENERATORS

DGUH2.7S-2	3.3	2700W	HONDA GX200	72 dBA	40	650 x 435 x 415
DGUH3.5S-2	4.4	3500W	HONDA GX270	67 dBA	60	735 x 520 x 500
DGUH5S-2	5.8	4800W	HONDA GX340	73 dBA	70	735 x 520 x 500
DGUH6S-2	7.0	5600W	HONDA GX390	69 dBA	75	735 x 520 x 500
DGUH6ES-2	7.0	5600W	HONDA GX390	69 dBA	80	735 x 520 x 500
DGUH7S-2	8.0	6000W	HONDA GX390	76 dBA	80	810 x 520 x 525
DGUH7ES-2	8.0	6000W	HONDA GX390	76 dBA	85	810 x 520 x 525
DGUH9ES-2	9.5	7500W	HONDA GX630	75 dBA	110	876 x 546 x 700
DGUH11ES-2	11.0	8500W	HONDA GX630	75 dBA	110	876 x 546 x 700
DGUH11E-3S-2	12.0	9600/3W	HONDA GX630	75 dBA	130	876 x 546 x 700
DGUH15ES-2	15.0	12000W	HONDA GX690	75 dBA	160	876 x 546 x 700
DGUH16E-3S-2	16.0	12000/3W	HONDA GX690	75 dBA	165	876 x 546 x 700

## DUNLITE DIESEL GENERATORS

DGUKD6.5ES-2	6.5	5200W	KOHLER KD440	89 dBA	100.5	810 x 550 x 560
DGULD6.8ES-2	6.8	5600W	LISTER K172E	80 dBA	110	810 x 545 x 545
DGUYD6.8ES-2	6.8	6000W	YANMAR L100N5	89 dBA	110	810 x 550 x 560
DGUKD8.5ES-2	8.5	7000W	KOHLER 12.5 HP	80 dBA	166	890 x 570 x 720
K-MAX 5	5	4400W	LISTER K172		163	
K-MAX 10	10	8800W	LISTER KV2-80		280	

## DUNLITE HONDA MULTI-POWER PACKS PETROL POWERED

MPP-MINI (RECOIL START)	4.4		HONDA GX270	67 dBA	85	735 x 545 x 525
MPP (RECOIL START)	7.0	6000W	HONDA GX390	69 dBA	110	900 x 870 x 680
MPPE (ELECTRIC START)	7.0	6000W	HONDA IGX390	69 dBA	112	900 x 870 x 680

## MINE SPEC DIESEL GENERATORS

DGUKD6.5ES-MINE	6.5	5200W	KOHLER KD440	89 dBA	158	876 x 546 x 700
DGULD6.8ES-MINE	6.8	5400W	LISTER K172E	80 dBA	165	876 x 546 x 700
DGUYD6.8ES-MINE	6.8	5400W	YANMAR L100N5	80 dBA	165	876 x 546 x 700
DGUKD8.5ES-MINE	8.5	6800W	KOHLER 25LD	80 dBA	172	876 x 546 x 700

## MINE SPEC OPTIONS & ACCESSORIES

WHEEL KIT-400-4	4 WHEELS ATTACHED TO FRAME FOR EASY TRANSPORTATION
80-EARTH STAKE	COPPER EARTH STAKE WITH EARTH CABLE



DGUH3.5S-2

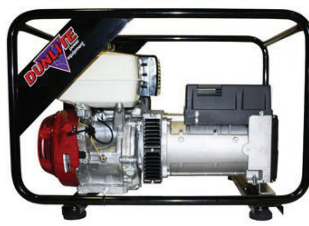

DGUH7S-2



DGUKD6.5ES-2



DGUKD8.5ES-2

PRICES EXCLUDE GST

T: (08) 9362 6811

103

F: (08) 9361 3263

# AIR COMPRESSORS

ORDER NO	DISP CFM	FAD CFM	HP	CYL	TANK (LTR)	WEIGHT (KG)	DIMENSIONS (L x W x H)
----------	----------	---------	----	-----	------------	-------------	------------------------

## WESTAIR 12 / 24 VOLT AIR COMPRESSORS

DC12	4	1.3	0.5	1	N/A	7.5	33 X 12 X 21
DC1208	4	1.3	0.5	1	8	19.5	42 X 38 X 33
DC24	5.5	2.6	0.5	1	N/A	7.5	33 X 12 X 21
DC2408	5.5	2.6	0.5	1	8	19.5	42 X 38 X 33

## WESTAIR BELT DRIVE SINGLE PHASE AIR COMPRESSORS

WE12/54	11.2	8.3	2.2	2	80	69	100 X 38 X 74
WE18/54*	15.1	11.3	3	2	80	82	100 X 38 X 74
WE18/110*	15.1	11.3	3	2	150	127	135 X 46 X 86

## WESTAIR 3 PHASE BELT DRIVE 415VOLT AIR COMPRESSORS

WA20/110	19.2	12.7	4	3	110	140	135 X 40 X 85
WA27/110	26.3	18.0	5.5	2	110	160	135 X 45 X 85
WA35/110	34.0	28.3	7.5	3	110	175	135 X 50 X 100
WA35/200	34.0	28.3	7.5	3	200	220	175 X 50 X 100
WA45/250	42.5	35.8	10	3	250	270	175 X 50 X 100
WA65/250	64.5	52.0	15	4	250	295	175 X 50 X 100

## WESTAIR 3 PHASE BELT DRIVE QUIET CABINET 415VOLT AIR COMPRESSORS

WA25SC	27.8	20.2	5.5	2	N/A	230	80 X 75 X 105
WA35SC	35.1	24.2	7.5	3	N/A	270	80 X 75 X 111
WA45SC	46.5	38.9	10	3	N/A	290	80 X 75 X 111

## WESTAIR 3 PHASE BELT DRIVE QUIET CABINET 415VOLT PACKAGE WITH 190L VERTICAL RECEIVER

WA25SCP	27.8	20.2	5.5	2	N/A	230	80 X 75 X 105
WA35SCP	35.1	24.2	7.5	3	N/A	270	80 X 75 X 111
WA45SCP	46.5	38.9	10	3	N/A	290	80 X 75 X 111



PRICES EXCLUDE GST

T: (08) 9362 6811

104

F: (08) 9361 3263

# AIR COMPRESSORS

ORDER NO	DISP CFM	FAD CFM	ENGINE	CYL	TANK (LTR)	WEIGHT (KG)	DIMENSIONS (LXWXH)
<b>WESTAIR HONDA PETROL AIR COMPRESSORS</b>							
WP20/70	20.2	14.7	GX200	3	68	83	94 X 32 X 76
WP20/110	20.2	14.7	GX200	3	110	128	130 X 45 X 84
WP27/110	28.3	22.1	GX270	2	110	180	130 X 45 X 92
WP27/110ES			GX270				
WP38/110	37.6	29.0	GX390	3	110	190	130 X 45 X 97
WP38/110ES			GX390				
WP48/160	48.1	40.2	GX390	3	160	210	150 X 45 X 109
WP48/160S			GX390				

## WESTAIR KOHLER DIESEL AIR COMPRESSORS

WD20/70	20.2	14.7	KD225	3	70	90	100 X 48 X 75
WD20/120	20.2	14.7	KD225	3	116	130	128 X 46 X 88
WD27/120	26.1	18.6	KD350	2	116	179	128 X 46 X 95
WD38/120	37.6	29.0	KD440	3	116	205	128 X 53 X 103
WD48/120	48.1	40.2	KD500	3	116	207	128 X 53 X 103

## WESTAIR KOHLER PETROL AIR COMPRESSORS

WP20/70K	20.2	14.7	CH270	3	70	83	94 X 32 X 76
WP27/70K	28.3	22.1	CH395	2	70	87	105 X 40 X 85
WP38/110K	37.6	29.0	CH395	3	110	193	130 X 45 X 97
WP50/160K	52.6	41.4	CH440	3	160	213	150 X 45 X 109



WP14DD



WP20/70



WP27/70

## MARCHANT PNEUMATIC POST DRIVER O/N: 08PD102

The Marchant Pneumatic Post Driver is designed and manufactured in Australia for the harsh Australian Conditions.

It is capable of driving a large array of posts through bitumen, shale and black soil surfaces, as well as ironstone and sandstone. WEIGHT: 18KG

### KIT CONSISTS OF:

- Standard 54mm guide
- Striking dolly in the driver plus a spare striking dolly
- Quick release coupling & hose clamp to connect air hose direct to the driver
- Spare grub screws, lock nuts & allen key



08PD102

PRICES EXCLUDE GST

T: (08) 9362 6811

105

F: (08) 9361 3263

# WELDERS

## UNIFLAME CUTTING KITS O/N KK0XY1

### KIT INCLUDES :

- |                                 |                                  |
|---------------------------------|----------------------------------|
| 1 x Heavy Duty Tool Box         | 1 x Heating Tip                  |
| 1 x Oxygen Regulator            | 1 x Oxy Welding Goggles          |
| 1 x Acetylene Regulator         | 1 x Tip Cleaners                 |
| 1 x Blowpipe                    | 1 x Flint Lighter                |
| 1 x Cutting Attachment          | 2 x Flashback Arrestors (handle) |
| 1 x Mixer                       | 2 x Flashback Arrestors (regs)   |
| 1 x 10 Metre Twin Gas Hose      | 1 x Combination Spanner          |
| 3 x Welding Tips 8 / 12 / 15    | 1 x Radius Bar & Pivot           |
| 3 x Cutting Nozzles 8 / 12 / 15 | 1 x Roller Guide                 |



## UNIFLAME CUTTING KITS O/N KK0XY2

AS ABOVE except 1 x LPG Regulator (not Acetylene)

ORDER NO	VOLTS	TORCH	EARTH LEAD	REGULATOR	MAX CUT (MM)	WEIGHT (KG)	DIMENSIONS (L x W x H)
<b>UNIMIG PLASMA CUTTERS</b>							
KUPJRV40 Viper Cut	240V	TCBR50 Plasma	3M	YES	10	11.6	460 x 160 x 320
KUPJRRW45 Razor Cut	415V	Uni ARC CBR 150	4M	YES	16	21	540 x 220 x 370
KUPJRRW80 Razor Cut	415V	SC80 Plasma	4M	YES	28	16	560 x 220 x 415



KUPJRV40 Viper Cut



KUPJRRW45 Razor Cut



KUPJRRW80 Razor Cut

ORDER NO	DESCRIPTION	VIEWING AREA	INACTIVE SHADE	ACTIVE SHADE	ORDER NO INNER LENSE	ORDER NO OUTER LENSE
<b>UNIMIG WELDING HELMETS</b>						
UMMBWH	AUTO DARKENING RAZORBACK HELMET	100 X 60MM	4	9 - 13	UMRBIP	UMRBOP
UMVWH	AUTO DARKENING HELMET	96 X 42MM	4	9 - 13	UMIP	UMOP
UMRWWH	AUTO DARKENING HELMET	100 X 60MM	4	9 - 13	UMRBIP	UMRBOP
UMRWXWH	AUTO DARKENING / GRINDING HELMET	110 X 90MM	4	9 - 13	UMLIP	UMLOP



UMMBWH



UMVWH



UMRWWH



UMRWXWH

PRICES EXCLUDE GST

# WELDERS

	SPECIFICATIONS	
<b>KUMJRRW180CA</b>		
<ul style="list-style-type: none"> <li>Arc 170 Amp MMA/ TIG Welding Inverter</li> <li>4m ARC Welding Lead set 35-50mm Dinse style connections</li> <li>PVC carry case</li> <li>Optional TIG Torch 17V-4MCP50</li> <li>35/50 Dinse style connection TIG torch</li> <li>Optional Uni-Flame Flowmeter Argon Regulator.</li> </ul>	PRIMARY INPUT VOLTAGE	240V 1 PHASE
	RATED INPUT POWER	7.7 KVA
	RATED OUTPUT POWER	170A/ 26.8V
	DUTY CYCLE 40 DEG C	25% @ 170 AMPS MMA
	DUTY CYCLE 25 DEG C	100% @ 85 AMPS MMA
	WELDING CURRENT RANGE	10-170A
	WIRE SPOOL SIZE (KG)	NA
	WIRE SIZE (MM)	NA
	DIMENSIONS (MM)	320 X 120 X 210
	WEIGHT (KG)	5.2 KG
<b>KUMJRRW205SSMIG</b>		
<ul style="list-style-type: none"> <li>Uni-Mig 190 Multifunction Welding Inverter</li> <li>SB244M Unimig Sure Grip Ergo Mig Torch With Euro connection</li> <li>4M ARC Welding lead set 10-25mm dinse style connections</li> <li>Uni-Flame Twin Gauge Argon Regulator</li> <li>2M Gas Hose Complete with fittings</li> <li>Optional TIG Torch 17V-4MCP25 10/25 Dinse style connection TIG torch.</li> </ul>	PRIMARY INPUT VOLTAGE	240V 1 PHASE
	WELDING CURRENT MIG	30-190 AMPS
	VOLTAGE STEPS	10-160 AMPS
	DUTY CYCLE 40 DEG C - MIG	35% @175A / 100% @103A
	DUTY CYCLE 40 DEG C - MMA	35% @ 160A / 100% @95A
	WELDING VOLTAGE RANGE DC	15.5V - 23V
	WIRE SPOOL SIZE (KG)	1 KG & 5 KG
	WIRE SIZE (MM)	0.9-1.0 ALUMINIUM 0.9-1.2 FLUX CORED
	DIMENSIONS (MM)	480 X 230 X 360
	WEIGHT (KG)	19 KG
<b>KUMJRRW200MIG</b>		
<ul style="list-style-type: none"> <li>RAZORWELD 200 Welding Inverter</li> <li>SB244M Unimig Sure Grip Ergo Mig Torch with Euro connection</li> <li>Uni-Flame Twin Gauge Argon Regulator</li> <li>2M Gas Hose Complete with fittings</li> <li>10 metre ARC Welding Lead Set</li> <li>Trolley including tool draw</li> </ul>	PRIMARY INPUT VOLTAGE	240V 1 PHASE
	WELDING CURRENT MIG	20-250 AMPS
	VOLTAGE STEPS	10-250 AMPS
	DUTY CYCLE 40 DEG C - MIG	20% @200A
	DUTY CYCLE 40 DEG C - MMA	15% @ 200A
	WELDING VOLTAGE RANGE DC	11V - 29V
	WIRE SPOOL SIZE (KG)	1 KG & 5 KG
	WIRE SIZE (MM)	0.9-1.2 ALUMINIUM 0.9-1.2 FLUX CORED
	DIMENSIONS (MM)	470 X 190 X 380
	WEIGHT (KG)	12.5 KG
<b>KUMJR250</b>		
<ul style="list-style-type: none"> <li>Uni-Mig 250 Multifunction Inverter Welder</li> <li>SB244M Unimig Sure Grip Ergo Mig Torch with Euro connection</li> <li>Uni-Flame Twin Gauge Argon Regulator</li> <li>2M Gas Hose Complete with fittings</li> <li>4 metre ARC Welding Lead Set</li> <li>Optional Trolley UMJRTROLLEY3</li> </ul>	PRIMARY INPUT VOLTAGE	240V 1 PHASE
	WELDING CURRENT MIG	30-250 AMPS
	VOLTAGE STEPS	10-250 AMPS
	DUTY CYCLE 40 DEG C - MIG	35% @250A/100% @148A
	DUTY CYCLE 40 DEG C - MMA	35% @ 224A / 100% @137A
	WELDING VOLTAGE RANGE DC	15.5V - 22.5V
	WIRE SPOOL SIZE (KG)	5 & 15 KG
	WIRE SIZE (MM)	0.9-1.2 ALUMINIUM 0.9-1.2 FLUX CORED
	DIMENSIONS (MM)	580 X 230 X 450
	WEIGHT (KG)	24 KG



PRICES EXCLUDE GST

# WELDERS

	SPECIFICATIONS	
<b>KUMJR250SWF</b>		
<ul style="list-style-type: none"> <li>• Uni-Mig 250 SWF Multifunction Welding Inverter Complete with Separate Wire Feeder</li> <li>• 10 Metre Inter Connecting Cables</li> <li>• SB244M Unimig Sure Grip Ergo Mig Torch With Euro connection</li> <li>• Uni-Flame Twin Gauge Argon Regulator</li> <li>• 2M Gas Hose Complete with fittings</li> <li>• 10 metre ARC Welding Lead Set</li> <li>• Trolley including tool draw</li> </ul>	PRIMARY INPUT VOLTAGE	240V 1 PHASE
	WELDING CURRENT MIG	20-250 AMPS
	VOLTAGE STEPS	10-250 AMPS
	DUTY CYCLE 40 DEG C - MIG	35% @250A 100% @148A
	DUTY CYCLE 40 DEG C - MMA	35% @ 240A / 100% @137A
	WELDING VOLTAGE RANGE DC	11V - 29V
	WIRE SPOOL SIZE (KG)	5 & 15 KG
	WIRE SIZE (MM)	0.9 - 1.2 ALUMINIUM 0.9 - 1.2 FLUX CORED
	DIMENSIONS (MM)	1275 X 800 X 475
	WEIGHT (KG)	90 KG
<b>KUM270SWF</b>		
<ul style="list-style-type: none"> <li>• Uni-Mig 270 SWF Mig Welder</li> <li>• KT 50 Separate Wire Feeder complete with 10 metre interconnecting cables</li> <li>• SB244M Unimig Sure Grip Ergo Mig Torch with Euro connection</li> <li>• Uni-Flame Twin Gauge Argon Regulator</li> <li>• 2M Gas Hose Complete with fittings</li> <li>• 10 metre Earth lead with 35/50 Dinse style connections.</li> </ul>	PRIMARY INPUT VOLTAGE	240V 1 PHASE
	WELDING CURRENT MIG	30-250 AMPS
	VOLTAGE STEPS	21
	DUTY CYCLE 40 DEG C - MIG	70% @250A
	DUTY CYCLE 40 DEG C - MMA	100% @210A
	WELDING VOLTAGE RANGE DC	14V - 26V
	WIRE SPOOL SIZE (KG)	5 & 15 KG
	WIRE SIZE (MM)	0.9 - 1.2 ALUMINIUM 0.9 - 1.2 FLUX CORED
	DIMENSIONS (MM)	1270 X 880 X 475
	WEIGHT (KG)	139 KG
<b>KUM390SDSWF</b>		
<ul style="list-style-type: none"> <li>• Mig 390 S/D SWF Multifunction Welding Inverter complete with Separate Wire Feeder</li> <li>• Dual Voltage 415V 3 Phase or 480V Single phase (Rural Welder)</li> <li>• 10 Metre Inter Connecting Cables</li> <li>• SB364M Unimig Sure Grip Ergo Mig Torch with Euro connection</li> <li>• Uni-Flame Twin Gauge Argon Regulator</li> <li>• 2M Gas Hose Complete with fittings</li> </ul>	PRIMARY INPUT VOLTAGE	480V 2 PHASE
	WELDING CURRENT MIG	40-375 AMPS
	VOLTAGE STEPS	30
	DUTY CYCLE 40 DEG C - MIG	70% @355A
	DUTY CYCLE 40 DEG C - MMA	100% @300A
	WELDING VOLTAGE RANGE DC	16-32.5V
	WIRE SPOOL SIZE (KG)	5 & 15 KG
	WIRE SIZE (MM)	0.9 - 1.2 ALUMINIUM 0.9 - 2.4 FLUX CORED
	DIMENSIONS (MM)	1270 X 940 X 600
	WEIGHT (KG)	199 KG
<b>KUM500SWF</b>		
<ul style="list-style-type: none"> <li>• Uni-Mig 500 SWF Mig Welder</li> <li>• KT 90 Separate Wire Feeder complete with 10m interconnecting cables</li> <li>• TWC5-15FTE Sure Grip Ergo Mig Torch with Euro connections</li> <li>• 10m Earth lead with 35/50mm Dinse Style connections</li> <li>• Uni-Flame Twin Gauge Argon Regulator</li> <li>• 2m Gas Hose Complete with fittings</li> </ul>	PRIMARY INPUT VOLTAGE	415V 3 PHASE
	WELDING CURRENT MIG	50-450 AMPS
	VOLTAGE STEPS	50
	DUTY CYCLE 40 DEG 35%	450 AMPS
	DUTY CYCLE 40 DEG 100%	320 AMPS
	WELDING VOLTAGE RANGE DC	16-36V
	WIRE SPOOL SIZE (KG)	5 & 15 KG
	WIRE SIZE (MM)	0.9 - 1.2 ALUMINIUM 0.9 - 1.2 FLUX CORED
	DIMENSIONS (MM)	1270 X 940 X 600
	WEIGHT (KG)	199 KG



PRICES EXCLUDE GST

# WINCHES

PART NO	CATEGORY	VOLTS	RATING	DESCRIPTION	WIRE SIZE	WEIGHT
AL01572	BRAKE WINCH	NA	1500 LBS	WINCH AND CABLE COMPLETE WITH SAFETY HOOK		3.2 KG
AL01576	BRAKE WINCH	NA	2500 LBS	WINCH AND CABLE COMPLETE WITH SAFETY HOOK		6.8 KG
AL01577	BRAKE WINCH	NA	3500 LBS	WINCH AND CABLE COMPLETE WITH SAFETY HOOK		
AL02637	HAND WINCH	NA	440 LBS	HAND WINCH TWO WAY RATCHET		2.73 KG
AL01646	HAND WINCH	NA	900 LBS	HAND WINCH COMPLETE WITH CABLE AND SAFETY HOOK		2.4 KG
AL01633	HAND WINCH	NA	1200 LBS	HAND WINCH ONE WAY RATCHET FREE SPOOL IN OFF POSITION		3.0 KG
AL01637	HAND WINCH	NA	2000 LBS	HAND WINCH ONE WAY RATCHET FREE SPOOL IN OFF POSITION		6.0 KG
AL01511	TWO SPEED	NA	2500 LBS	HAND WINCH TWO SPEED SUPPLIED WITH CABLE AND SAFETY HOOK		6.4 KG
AL01624	ELECTRIC	12V	4000 LBS	ELECTRIC WINCH 2 HP	5.56MM	9 KG
AL01626	ELECTRIC	12V	6000 LBS	ELECTRIC WINCH 3.6 HP	7.94MM	31.8 KG
AL01629	ELECTRIC	12V	9500 LBS	ELECTRIC WINCH 4.5 HP	9.52MM	37 KG
AL02685	ELECTRIC	12V	12000 LBS	ELECTRIC WINCH 4.8 HP	9.52MM	43 KG
AL01675	ELECTRIC	12V	15000 LBS	ELECTRIC WINCH 7.3 HP	10MM	46 KG
AL01676	ELECTRIC	24V	15000 LBS	ELECTRIC WINCH 7.3 HP	10MM	46 KG
AL01680	HYDRAULIC	NA	9000 LBS	HYDRAULIC WINCH 80.6 cm <sup>3</sup> / REV	9.52MM	44 KG
AL01684	HYDRAULIC	NA	18000 LBS	HYDRAULIC WINCH	12.7MM	51 KG



PRICES EXCLUDE GST

T: (08) 9362 6811

109

F: (08) 9361 3263

# SNATCH STRAPS

## VEHICLE RECOVERY SNATCH STRAP

- Easy to handle and store
- Rot and mildew resistant
- Standard length 9M, other lengths made to order
- 20-30% stretch
- 100% nylon
- Ratings are break strengths
- Snatch strap rating should be 2-3 times vehicle GVM
- Anti recoil straps fitted for added safety
- 62T, 85T & 100T have protective sleeve over full length



ORDER NO	RATING	WEBBING	STANDARD LENGTH
<b>POLYESTER TOW ROPES</b>			
TS30T	30,000KG	FLAT WEB	9 METRE
TS60T	60,000KG	FLAT WEB	9 METRE
TS80T	80,000KG	FLAT WEB	9 METRE
TS105T	105,000KG	ROUND WEB	9 METRE
TS210T	210,000KG	ROUND WEB	9 METRE
TS300T	300,000KG	ROUND WEB	9 METRE
TS350T	350,000KG	ROUND WEB	9 METRE
TS400T	400,000KG	ROUND WEB	9 METRE
TS450T	450,000KG	ROUND WEB	9 METRE

ORDER NO	RATING	WEBBING	STANDARD LENGTH	WEIGHT
<b>NYLON SNATCH STRAPS</b>				
SN8.5T	8,500KG	60MM/1PLY	9 METRE	2.45KG
SN11.5T	11,500KG	75MM/1PLY	9 METRE	2.95KG
SN16T	16,000KG	60MM/2PLY	9 METRE	4.3KG
SN26T	26,000KG	75MM/2PLY	9 METRE	5.1KG
SN32T	32,000KG	100MM/2PLY	9 METRE	7.35KG
SN50T	50,000KG	150MM/2PLY	9 METRE	11.1KG
SN62T	62,000KG	100MM/4PLY	9 METRE	16.8KG
SN85T	85,000KG	150MM/4PLY	9 METRE	22KG
SN100T	100,000KG	60MM/1PLY	9 METRE	29KG
SN150T	150,000KG	60MM/1PLY	9 METRE	36KG

PRICES EXCLUDE GST

T: (08) 9362 6811

110

F: (08) 9361 3263



# CAMERA KITS

ORDER NO	VOLTAGE	DESCRIPTION
<b>CAMERA KITS</b>		
AGCMK3	12 VOLT	7" TFT TOUCH SCREEN LCD DIGITAL REAR VIEW MONITOR, 22PIN, SUITS UP TO 4 CAMERA INPUTS SUPPLIED WITH 2 X 120 DEGREE CAMERA/CABLE
<b>MONITOR SCREEN ONLY</b>		
AGCMM700	12 VOLT	7" TFT TOUCH SCREEN LCD DIGITAL REAR VIEW MONITOR, 22PIN, SUITS UP TO 4 CAMERA INPUTS
<b>CAMERA'S AND ACCESSORIES</b>		
AGCMC120	12 VOLT	1/4" CCD COLOR CAMERA WITH AUDIO AND IR, PAL, 120°, MIRROR IMAGE, 4PIN DIN, BLACK
AGCMAMP	12 VOLT	4-CH COLOR MULTIPLEXER IS NEEDED IF YOU WANT TO VIEW UP TO 4 CAMERAS ON THE SCREEN AT THE SAME TIME
AGCMAC5	NA	5M 4PIN EXTENSION CABLE
AGCMAC10	NA	10M 4PIN EXTENSION CABLE
AGCMAC15	NA	15M 4PIN EXTENSION CABLE
AGCMAC20	NA	20M 4PIN EXTENSION CABLE
AGCMAC16	NA	1.6M TRAILER CABLE CONNECTS TWO CAMERAS INTO ONE CABLE
<b>CAMERA WIRELESS KITS</b>		
AGCMWK1	12/24/36	7" INCH TFT LCD COLOUR SCREEN AV INPUT AND INPUT FOR 2 CAMERA'S WIRELESS, WATER PROOF DAY/NIGHT CAMERA CABLE AND ANTENNA'S SUPPLIED
AGCMWC80	12	WIRELESS WATERPROOF CAMERA



AGCMM700



AGCMWK1



AGCMC120



AGCMWC80



AGCMAMP



AGCMAC10



AGCMAC16

PRICES EXCLUDE GST

T: (08) 9362 6811

111

F: (08) 9361 3263

# SERVICE

## DID YOU KNOW...

- Agriparts has an extensive workshop.
- Whether it's lathe work, milling or gear cutting... we have the capabilities.

We are also the authorised Comer Industries service centre for all Comer Industries Gearboxes, PTO Shafts and Planetarys.

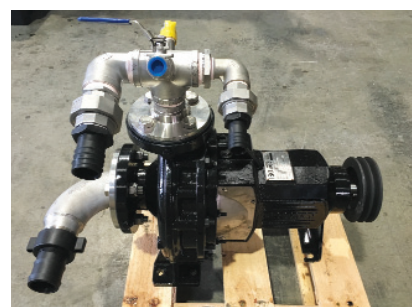

PRICES EXCLUDE GST

T: (08) 9362 6811

112

F: (08) 9361 3263

[www.agriparts.com.au](http://www.agriparts.com.au)

FOR ALL ENQUIRIES PLEASE CONTACT P: 08 9362 6811 F: 08 9361 3263  
29 WELSHPOOL RD, WELSHPOOL WA 6106, WESTERN AUSTRALIA PO BOX 232 CLOVERDALE WA 6985  
Email: [sales@agriparts.com.au](mailto:sales@agriparts.com.au)

PRODUCTS AND PRICES ARE SUBJECT TO CHANGE WITHOUT NOTICE



AGRIPARTS  
& REPAIRS

29 WELSHPOOL ROAD, WELSHPOOL WA 6106

[sales@agriparts.com.au](mailto:sales@agriparts.com.au)

PH: + 61 (8) 9362 6811    FAX: +61 (8) 9361 3263

[www.agriparts.com.au](http://www.agriparts.com.au)